

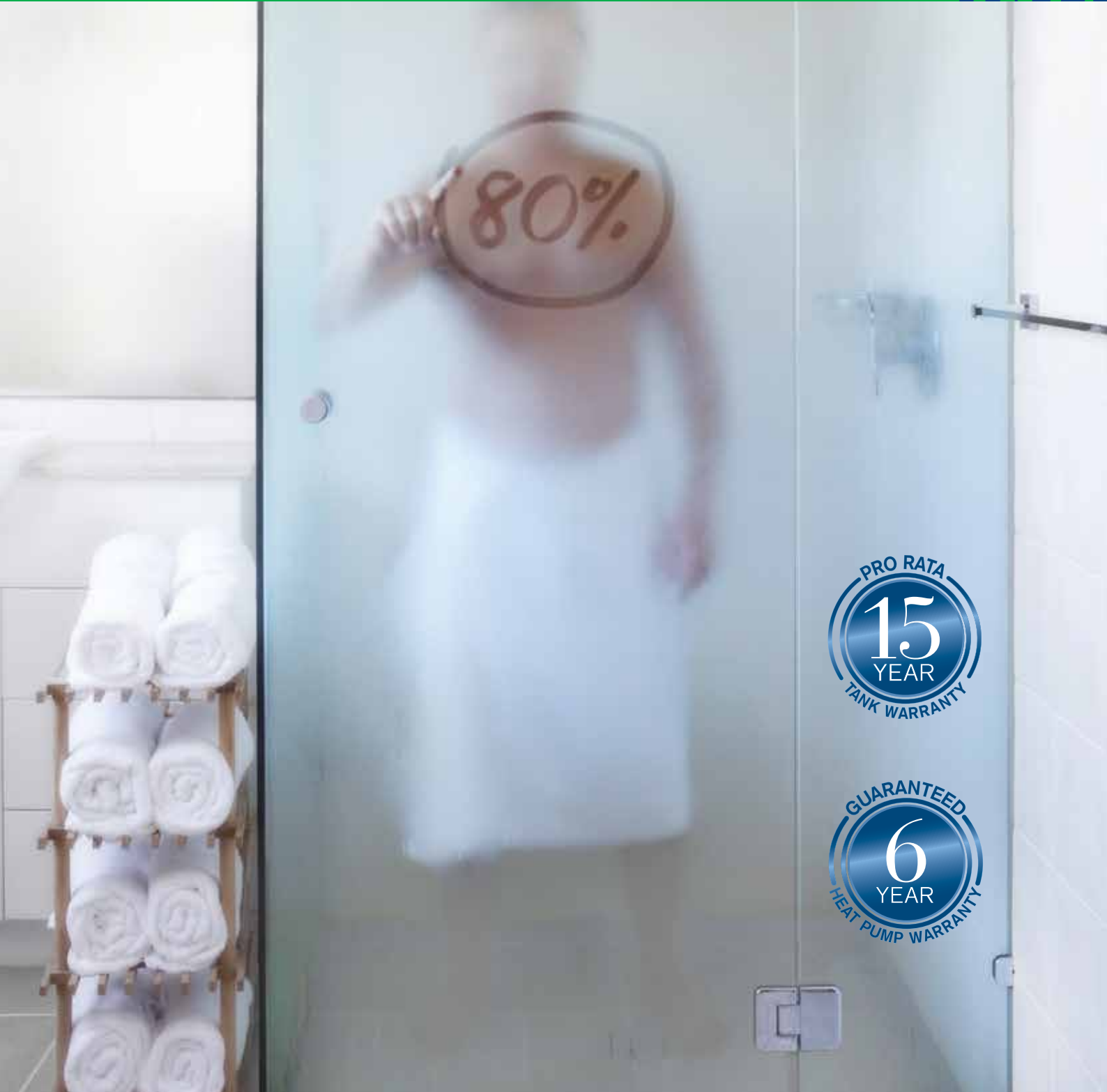

SANDEN

Save up to 80%* of your hot water energy costs... rain, hail or shine!



PRO RATA
15
YEAR
TANK WARRANTY

GUARANTEED
6
YEAR
HEAT PUMP WARRANTY

SANDEN. Leading hot water technology

Enjoy the higher STC rewards even before you turn a hot water tap on.

The new Sanden Eco® Plus system is the most energy efficient hot water heat pump currently available on the market. As such, when you buy a Sanden system, you receive the highest amount of Small-scale Technology Certificates (STCs) of any currently available hot water heat pump system. These STCs can be used to discount your purchase price. For more information, ask your local Sanden Dealer or visit www.climatechange.gov.au or www.cleanenergyregulator.gov.au



STC Rebate Zones

A Small-scale Technology Certificate (STC) is the equivalent of one megawatt hour of renewable energy generation. The new Sanden Eco® Plus Hot Water Heat Pump System attracts the STCs below, which can be traded for a cash rebate. Eligible households can also claim State rebates.

Model	STC Zone				
	1	2	3	4	5
GAUS-160EQTAQ*	27	24	32	35	34
GAUS-250EQTAQ*	27	25	32	35	34
GAUS-315EQTAQ*	27	24	33	35	34

* Refer to back page for technical specifications | Notes: This table details the number of STCs registered by The Clean Energy Regulator (CER) for the Sanden Eco® Plus Hot Water Heat Pump System. STC values are subject to change without notice and are correct at time of printing. STC calculations are based on continuous tariff.

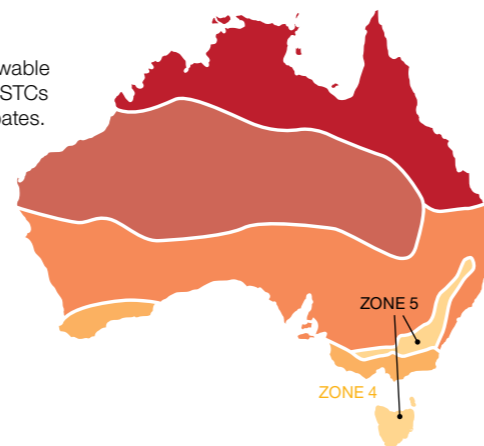

Sanden. Striving to develop 'Environmentally Advanced' Products.

Sanden is a Japanese owned global business, which has earned a solid reputation as a leader in the field of heating and cooling technology. Our focus is to improve the living standards of all Australians, via the development of environmentally advanced products. Sanden has been operating in Australia for over 35 years.



Established: July 30, 1943
Paid Up Capital: AUD 122.6 million†
 AUD1 = JPY90
Sanden Companies: 30 (In Japan), 54 (Overseas)
Number Of Employees: 4328 (In Japan), 8215 (Overseas)
Net Sales: AUD 3,410.9 million†
 AUD1 = JPY90

Sanden has 3 core businesses:

1. Automotive Air Conditioning Systems

Sanden has more than 50 years experience in the production and global supply of air conditioning compressors. It currently supplies some of the world's leading automotive brands, including VW, Honda, Ford,

Audi, Rolls Royce, Peugeot, Citroen, Renault, Landover, Fiat, Mercedes Benz & Kenworth.

2. Commercial Refrigeration & Vending Machines

Sanden's extensive range of innovative and environmentally sustainable refrigerator/freezer showcases and "energy & labour saving" vending machines is used in convenience stores, restaurants, cafes and supermarkets and preferred by world leading brands, including 7Eleven, Coca Cola, Pepsi and Schweppes.

3. Household Living & Environment Systems

Sanden has applied its advanced understanding of heat transfer technologies to the home environment, resulting in the development of the highly innovative and superior Sanden Eco® Plus Hot Water Heat Pump system, which is manufactured in-house at Sanden's "state of the art" factory in Japan.

Why consider an Air-Sourced Hot Water Heat Pump System?

An air-sourced heat pump absorbs heat from the air and transfers it to heat water. It runs on electricity but is roughly three times more efficient than a conventional electric water heater. It is designed to save energy and money and reduce greenhouse gas emissions.

Why purchase a Sanden Eco® Plus Hot Water Heat Pump System?

The superior design of a Sanden Eco® Plus Hot Water Heat Pump ensures:

- Industry leading energy efficiency using only 20% of the energy required by an electric storage hot water system.
- Innovative technology - up to 50% faster heat recovery than currently available Hot Water Heat Pumps.
- Perfect to use with Off-Peak Electricity for even more savings.
- The most STC rewards for energy efficiency, means you enjoy a greater discount on the purchase price.
- Class leading warranties, backed by Sanden's 35 years of operation in Australia.
- Split system for ease of installation and near silent operation.

How a Sanden Eco® Plus System Works.

The Sanden Eco® Plus Hot Water Heat Pump System uses a small amount of energy to move heat from one location to another. Heat is absorbed by ozone-friendly R744 (CO₂), a natural refrigerant which does not contribute to global warming. As the warm gaseous refrigerant circulates through the system it passes through the compressor, and its pressure and temperature rises. The hot refrigerant then passes through a heat exchanger which heats the water. The refrigerant is cycled back into the system, and hot water is pumped to the storage tank.

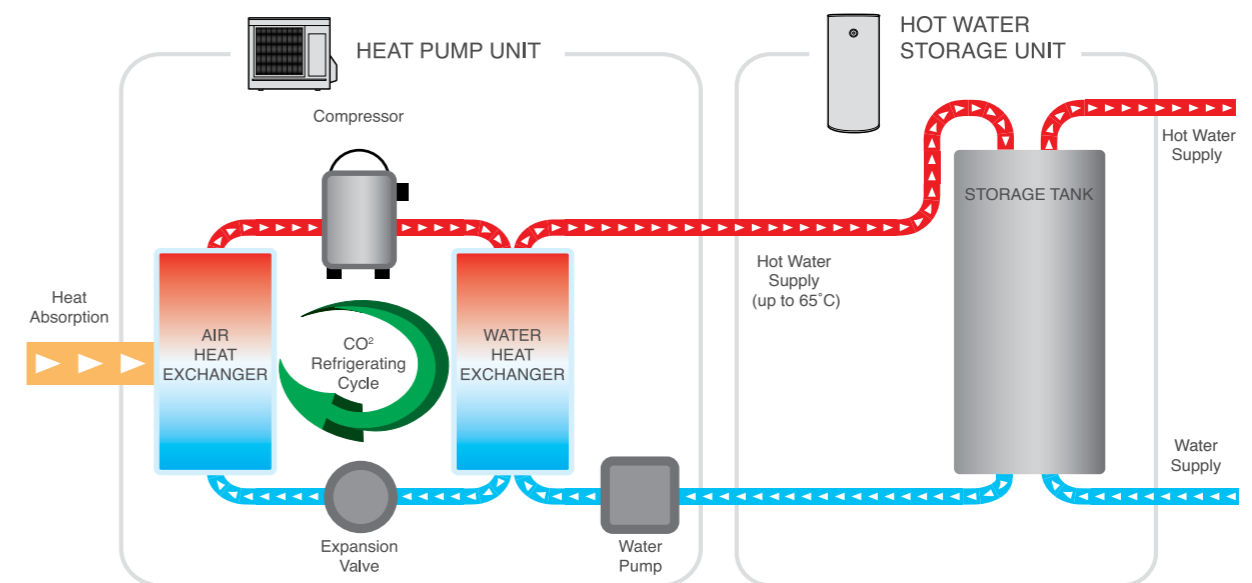

Superior Features and Benefits.

Unlike other hot water heat pump systems, the Sanden Eco[®] Plus system uses a smarter split system where the heat pump unit and stainless steel tank are installed separately. This allows easy on-site handling and installation, as well as flexibility of the storage tank location, which can be up to 15 metres distance horizontally or 5 metres vertically from the heat pump unit.

Heat Pump Unit

- A high Coefficient of Performance (COP=5[^]) results in significantly reduced energy use and CO² emissions.
- Up to 50% faster heat recovery than typical heat pumps. In ambient air of 20°C it takes approx 4 hours to heat 315 L of water from 17°C to 65°C.
- Uses unique Ozone friendly R744 (CO²) refrigerant.
- Simple installation by Plumber & Electrician, with no Refrigeration Mechanic required.
- An automatic heating cycle, which makes it perfect for use with Off-Peak tariff.
- Uniquely designed to operate in all climates (ie. -10°C to +43°C operating range).
- Includes Blockout Timer, for use with on-roof photo voltaic (PV) solar electricity systems.
- No backup element required.
- Whisper quiet operation, with industry leading noise level of 37 dB - very neighbour friendly!
- High quality, Japanese made weather resistant construction for outdoor location.
- 6 year Warranty.



Stainless Steel Tank

- 3 x tank sizes offered – 160L, 250L and 315L.
- High quality, Australian made extra long life 316 Marine Grade stainless steel cylinder.
- Fully insulated for minimal heat loss.
- Mains pressure rated.
- Safety pressure and temperature relief valve supplied.
- 15 year Warranty.

How Sanden delivers better Performance and Savings.

Sanden employs superior R744 (CO²) refrigerant technology, so that the amount of electrical energy required to heat the water is significantly less than that required by a conventional electric storage hot water system. In fact, the Sanden Eco[®] Plus Hot Water Heat Pump System consumes 1kW of electricity to generate 4.5 kW of heat (COP = 5[^]), which equates to 20% of the energy used by a conventional electric storage system. Consequently, with the Sanden Eco[®] Hot Water Heat Pump System, you can save up to 80% of your conventional electric storage hot water energy costs!

Greenhouse CO² Emissions from Hot Water Systems

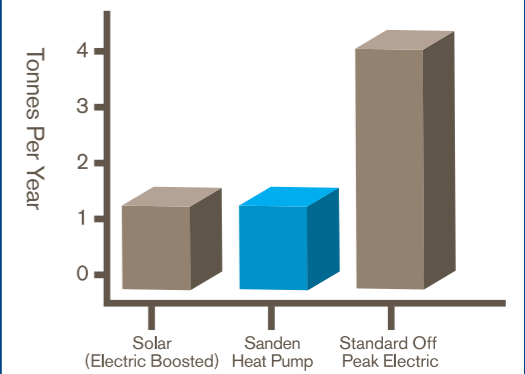

Source: Department of Environment & Climate Change NSW

Eco-Friendly - Why employ R744 (CO²) refrigerant?

- It offers no ozone layer depletion and minimal global warming (ie. as per table below) versus other commonly used refrigerants, should the system leak.
- It performs higher compression efficiency, with lower energy consumption, thereby allowing more heat to be transferred to the water, for less energy used (i.e. excellent thermodynamic ability).
- The refrigerant temperature gets very hot, very quickly, so water temperature of 65°C, is achieved almost instantly.
- Sanden is the only currently available HWHP in Australia, to employ "ozone friendly" R744 (CO²) refrigerant.

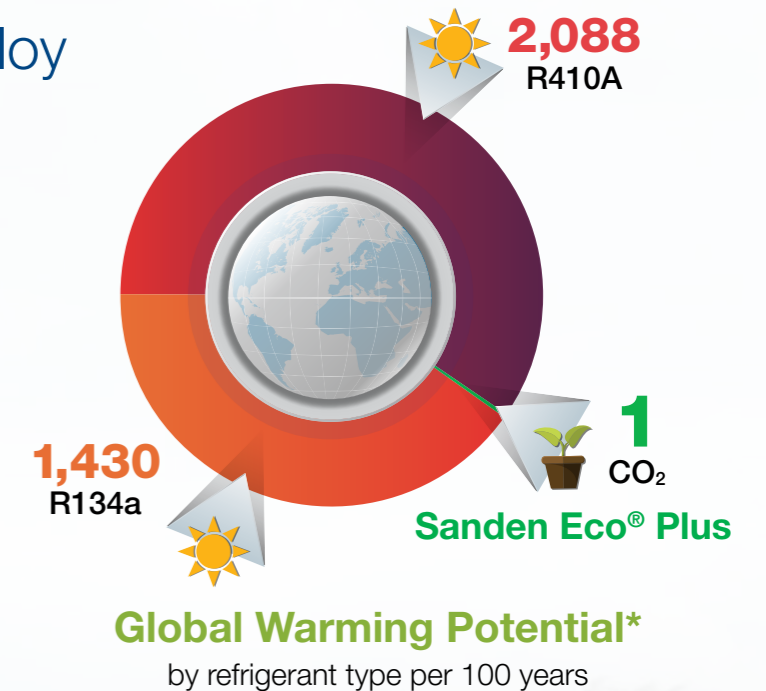

*Global warming potential (GWP) is a measure of how much a given mass of greenhouse gas is estimated to contribute to global warming. It is a relative scale which compares the gas in question to that of the same mass of carbon dioxide (whose GWP is by convention equal to 1). A GWP is calculated over a specific time interval and this time interval must be stated whenever a GWP is quoted or else the value is meaningless.

Years of worry free hot water – we guarantee it

Every Sanden Eco[®] Plus Hot Water Heat Pump System is fully backed by our extended warranties. Sanden Eco[®] Plus Hot Water Heat Pump units feature a 6 year class leading warranty, while the stainless steel storage tank also has a class leading 15 year warranty, providing you with peace of mind.

For full warranty conditions, please refer to www.sanden-hot-water.com.au

The Sanden warranty applies alongside, and in addition to, any rights or remedies to which you may be entitled under the Australian Consumer Law.

Refrigerant ASHRAE Number	IUPAC Chemical Name	Net GWP per 100 years
R744	Carbon Dioxide	1
R12	Dichlorodifluoromethane	10,900
R22	Chlorodifluoromethane	1,810
R134a	1,1,1,2-Tetrafluoromethane	1,430
R410a	R32/R125 (50/50)	2,087.5

See also:

http://en.wikipedia.org/wiki/Global_warming_potential
http://en.wikipedia.org/wiki/List_of_refrigerants



Whisper Quiet Operation.

When purchasing a hot water heat pump system, noise levels are an important consideration.

Sanden's extensive research has delivered a 'whisper quiet' operating noise level (37dB) that ensures both you and your neighbours' lifestyles remain unaffected by its operation.



Source
www.noisehelp.com

dB	EXAMPLE	APPLIANCES
0	healthy hearing threshold	
10	a pin dropping	
20	rustling leaves	
30	whisper	SANDEN ECO® PLUS
40	babbling stream	computer
50	light traffic	refrigerator
60	conversational speech	air conditioner
70	shower	dishwasher
80	alarm clock	garbage disposal
90	squeeze toy	lawn mower
100	motorcycle (riding)	
110	rock band	
120	thunderclap	
130	peak stadium crowd noise	
140	jet engine at takeoff	
150	fighter jet launch	
160	shotgun	
170	safety airbag	
180	rocket launch	

Hot Water Systems Energy Usage Comparisons

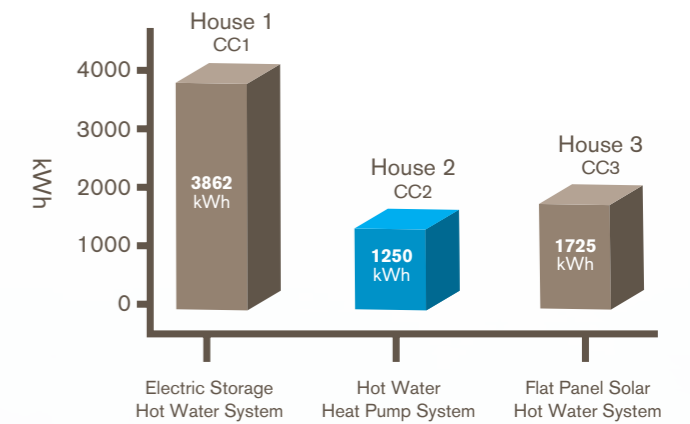

- House 1 (CC1) - Electric, 50 gal capacity, EF=0.86, usage= 60 gal/day, set temp=120°F
- House 2 (CC2) - Hybrid Electric Heat Pump Water Heater, 50gal, EF =2.4, set temp = 120°F, usage=60 gal/day
- House 3 (CC3) - Solar Water Heater, 85 gal, EF =0.91, set temp = 120°F, 60 ft² collector area, electric pumps, usage=60 gal/day

*Source: <http://cchouse1.dyndns.org:83/dashboards/Campbell%20Creek%20Fact%20Sheet.pdf>



Did you know that Heat Pump technology is more energy efficient than Solar?

During the period 2009 - 2013, the Campbell Creek Energy Efficient Home Project* compared the energy usage of three homes, each with different types of water heaters.

Test results for the period January to December 2012, confirmed that the Solar Flat Panel system used 38% more energy than the Hot Water Heat Pump.

CASE STUDY

Cost savings achieved by a Sanden Eco® Hot Water Heat Pump System versus a conventional electric hot water system.

The table presents electricity consumption figures recorded by a Sanden customer, who replaced his conventional electric Rheem Hot Water System with a Sanden Eco® Hot Water Heat Pump System, on 4.10.10. He lives in the Sydney Metro area, has a family of 4 people (ie. Husband, Wife & 2 x Children) using hot water and uses Off-Peak Controlled Load 2.

As can be seen, the reduction in usage achieved for the 2010/11 period, versus prior year, was approx. 80%, while the reduction in \$ Cost for the same period was 77% and this was despite a change of supplier and a more expensive tariff (ie. increase of 18.7%).



From	To:	Days:	Rate (c/kWh)	Supplier	Usage (kWh)	Cost (\$)
13.10.08	12.01.09	91	7.89	Integral	1368	107.90
12.10.09	11.01.10	91	9.58	Integral	1347	129.08
13.10.10	13.01.11	93	11.37	IntegralAGL	265	30.12

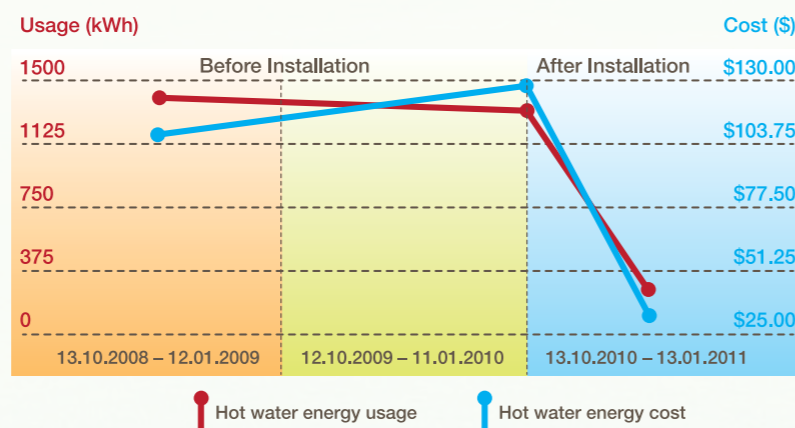

3 x Tank Sizes Available

The Sanden Eco® Plus Hot Water Heat Pump System is available with any one of 3 tank sizes - 160L, 250L, 315L. Each tank is combined with the Sanden Eco® Plus Heat Pump Unit, as listed below.

Tank size/shape	No. of persons using hot water	Typical dwelling type	Suitable for Off-peak & Continuous tariffs?	STC rebates available?
160L	2-4	Units/Townhouses	Continuous only	Yes
250L	3-5	Residential	Both	Yes
315L	4-6	Residential	Both	Yes

IMPORTANT INFORMATION

Please Ensure Your Water Quality Is Within Specification.

Water supply quality

Chloride and pH

In high chloride water supply areas, the water can corrode some parts and cause them to fail. Where the chloride level exceeds 200 mg/litre warranty does not apply to the heat pump unit and tank unit. pH is a measure of whether the water is alkaline or acid.

In an acidic water supply, the water can attack the parts and cause them to fail. No warranty applies to the heat pump unit and tank unit where the pH is less than 6.0. The water supply from a rainwater tank unit in a metropolitan area is likely to be corrosive due to the dissolution of atmospheric contaminants.

Water with a pH less than 6.0 may be treated to raise the pH. It is recommended that an analysis of the water from a rainwater tank be conducted before connecting this type of water supply to the system.

Change of water supply

Changing, or alternating, from one water supply to another can have a detrimental effect on the operation and/or life expectancy of the water tank unit cylinder, PTR valve, water heating circulation and the heat exchanger in the system. Where there is a changeover from one water supply

to another, for example, a rainwater tank supply, desalinated water supply, public reticulated water supply or water brought in from another supply, then water chemistry information should be sought from the supplier or the water should be tested to ensure it meets the requirements of our Sanden Eco® Plus Hot Water Heat Pump System warranties.

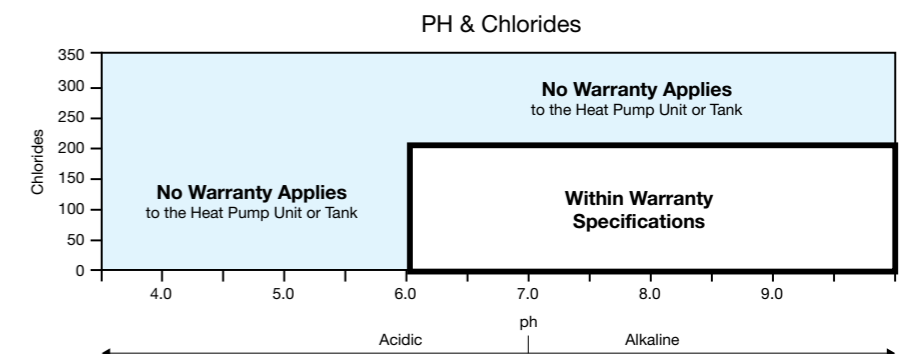

Specifications

Heat Pump

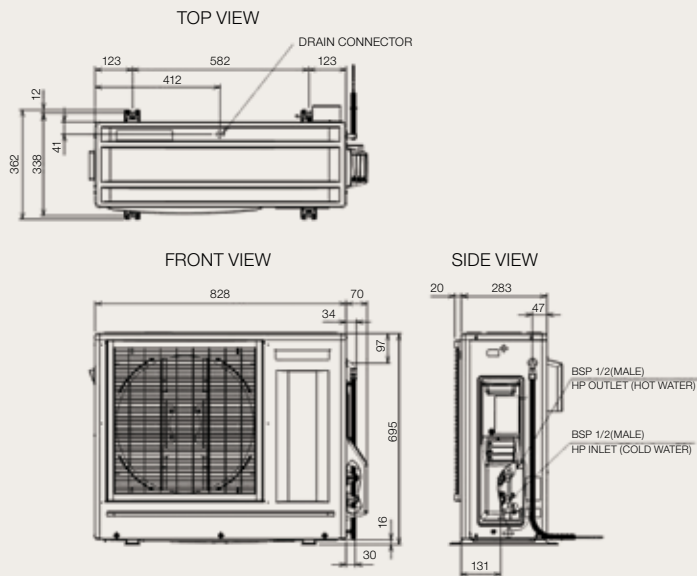

All dimensions displayed in millimetres

Dimensions	
Weight	48 kg
Technical	
Power Input	0.9kW
COP (Heating Efficiency)	5.0 ^
Refrigerant	CO ² (R744)
Water Temperature Setting (Nominal)	60°C
Compressor	Variable
Electrical Supply	220 – 240V/50Hz/1Ph
Circuit	20Amps
Operating Noise Level	37 dB
Ambient Air Operating Temperature	-10°C to +43°C
Water Connections & Settings	
Inlet	½" BSP, 12.7 mm
Outlet	½" BSP, 12.7 mm
Country of Manufacture	Japan

Note: Materials and specifications are subject to change without notice.

Stainless Steel Storage Tank

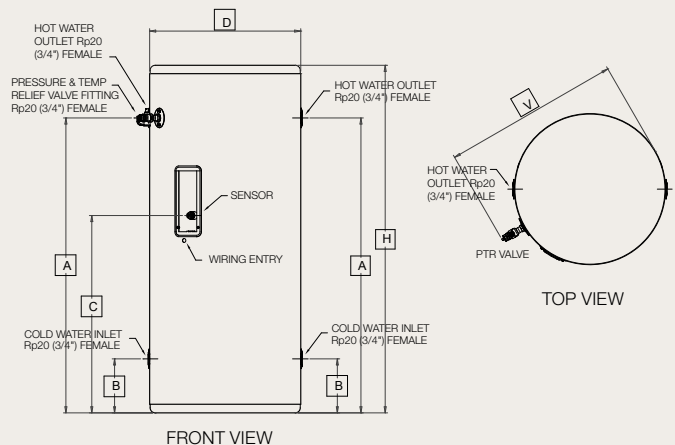

Model No:	GAUS-315EQTAAQ	GAUS-250EQTAAQ	GAUS-160EQTAAQ
H Height	1748 mm	1428 mm	970 mm
A Hot Water Outlet & PTR Valve	1531 mm	1212 mm	753 mm
C Sensor Port	1027 mm	708 mm	249 mm
B Cold Water Inlet / Heat Pump Flow	221 mm	222 mm	223 mm
D Diameter	621 mm	621 mm	621 mm
Weight	55 kg approx.	45 kg approx.	29 kg approx.
Storage Capacity	315L	250L	160L

Water Connections & Settings			
Tank Relief Valve Setting (PTR Valve)	700 (kPa)	700 (kPa)	700 (kPa)
Expansion Control Valve Setting (ECV) (kPa)	600 (kPa)	600 (kPa)	600 (kPa)
Maximum Mains Pressure Settings			
With ECV	500 (kPa)	500 (kPa)	500 (kPa)
Inlet Water Operating Pressure	500 (kPa)	500 (kPa)	500 (kPa)
Adjustable Tempering Valve	1400 (kPa)	1400 (kPa)	1400 (kPa)
Hot and Cold Connection	Rp 20 (3/4") Female	Rp 20 (3/4") Female	Rp 20 (3/4") Female
WaterMark Licence No.	WM-022333	WM-022333	WM-022333
Colour	Colourbond Salt Bush	Colourbond Salt Bush	Colourbond Salt Bush
Country of Manufacture	Australia	Australia	Australia

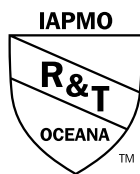

Sanden International (Australia) Pty. Ltd.
 6/17 Willfox Street, Condell Park, NSW 2200
 PO Box CP296, Condell Park, NSW 2200
 Sales Enquiries: 1800146123 or (02) 9791 0999
 Sales Fax: (02) 9791 6601
 Email: sales@sanden.com.au
 Website: www.sanden-hot-water.com.au

* Calculated using ORER methodology
 ^ Tested under AS/NZ5125 requirements
 # It takes just 4 hours to heat 315L of water, from 17°C to 65°C, in ambient air of 20°C.
 † Fiscal 2015

Sanden Dealer: