



CATALOGUE

ACCESSORIES FOR:

- FIREPLACES
- PIZZA OVENS
- OUTDOOR HEATING

S & D BERG TRADING PTL LTD

● Warehouse: 11A Clarice Road, Box Hill Sth., Victoria 3128

● Phone: (03) 9890 1634 - Email: sales@sdberg.com.au





Hover over a page number and click to go directly to that page in the catalogue

Index

B		Fire Tools		R	
Bellows	21	Black 2 Pce Floor Set.....	21	Rubbedin	
Buckets		Economy Range	50	Black Patch Putty	14
Bucket/Shovel /Brush Combo.....	24	Fire Shovels.....	23	Cast Iron Stove Polish.....	14
Gal Bucket.....	24	Mid Range.....	49	Hot Glass Cleaner	14
Round Wood Bucket	56	Poker	22	Hot Spot Mortar	14
Tapered Wood Bucket	56	Scraper.....	22	Instant Brick	14
		Tongio	43-44	Pot-Belly Black	14
		Tongio Riviera Series.....	47	Soot Loose.....	14
		Tongio Standard Range.....	45-46		
		Tongs.....	22	S	
		With Mesh Stand.....	48	Scrapers	
				Scraper.....	22
C		Flue Brushes		Shovels	
Child Guards		Flexi Kit	17	Fire Shovel Short Handle.....	23
Universal Hearth Gate.....	28-29	Flue Brush Kits	16	Soot Loose	14
Cleaner		Gal Wire Head - Pull Thrus.....	19		
Glass Door Cleaner	9	Polypropylene - Pull Thrus	19		
Covers		Professional Strength	20	W	
Chiminea Cover	72-73			Wood Buckets	
		G		Round	56
D		Gloves		Tapered.....	56
Door Glass Cleaner	9	Gauntlets	26	Woodbin	57
		Grates		Wood Carriers	
F		Heavy Duty, Spanco.....	74-75	Wood Porta	
Fibreglass Rope		Heavy Duty Steel	21	Deluxe	55
2m Length Packs	10			Wood Ring with Tray	54
Bulk Packs.....	11	M		Wood Sling.....	59
Fire Bricks		Moisture Meter		Wood Heater	
Fire Bricks.....	12	Digital Moisture Meter.....	26	Door Class Cleaner	9
Fire Grates		O		Wood Storage	
Cast Iron	21	Outdoor Heating		2 Tier Wood Rack	
Heavy Duty Steel, Spanco.....	74-75	Firepit Covers.....	72	with Firetools	55
Firelighters		Patio Heater Cover	73		
Sureburn Firelighters.....	13	P			
Fire Screens		Pizza Accessories			
3 Fold Pattern	39	3 Tier Pizza Rack	68		
Economy Range	41	Pizza Spatula	67		
Leaf Design	39	PIZZA OVEN TOOLS	60-65		
Premium Range		Pokers			
Fixed Wing	38	Poker	22		
Hinged Wing.....	38	Pyrogrip	12		
with gate.....	37				

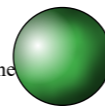



SECTION A
GOODS INVOICED BY
S & D BERG TRADING PTY LTD
Contents

**FIREPLACE CONSUMABLES
AND MAINTENANCE8**

FLUE BRUSH KITS.....16

WOOD HEATER STARTER KIT25

CHILD GUARDS.....28

FIRE SCREENS.....36

FIRE TOOLS42

WOOD CARRIERS.....53

WOOD FIRED PIZZA OVEN TOOLS.....60

**DELUXE FIREPIT
& CHIMINEA COVERS72**



FOLDING FIREPIT

Go Anywhere

Easy To Assemble

Great for Camping

Folds into Small Bag



NEW

Mesh Replacement available

- Mesh sheet: 55cm W x 55cm L
- Fold-up Mesh Plate: 0.5mm 304 grade stainless steel
- Outer diameter of steel legs 12.7mm
- Mesh Plate Temperature resistance 450°C
- Holds up to 5kg of wood

Includes:
Carry bag with zipper and handle



Part No. OMFOLDPIT



9 325086 016297



Manufactured by
S & D Berg Trading Pty Ltd.



Log Holder

NEW



Part No. OFNIWR11

Black Powder Coated Finish

- Frame - Square Tubular Steel
- Assembled Size: - 44cm Wide x 36cm Deep x 38cm High.
- For Indoor Use Only



9 325086 016228



FIREPLACE CONSUMABLES AND MAINTENANCE



FIREPLACE ACCESSORIES



Part No. WHDGC



Single 2 pack



4 003364 606419



12 x 2 pack



4 003364 037008

Wood Heater Door Glass Cleaner

- 2 per pack - each 100mm long x 65/45mm wide x 20mm thick
- Double layer of premium fine steel wool on high quality sponge backing
- The elastic non woven fabric completely absorbs even the most stubborn soot and dirt
- Designed to fit the hand
- Fast effective dry cleaning - use without using any extra cleaning agent
- Guaranteed Scratch Free
 - Gentle and safe to use on all glass
 - Tested by independent testing lab in Germany
- Reuse several times
 - Simply knock off the soot
 - Do not rinse
 - Recommend using gloves as for all cleaning agents!

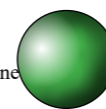



**Fibreglass Rope
IN 2 METRE LENGTH PACKETS
SOFT/MEDIUM WEAVE**

Part No. Size



6002 6mm diameter



9002 9mm diameter



1202 12mm diameter



1502 15mm diameter



1902 19mm diameter



2502 25mm diameter



2003 19mm x 2mm flat
Adhesive Backed tape -
Black



2503 25mm x 3mm flat
Adhesive Backed Tape -
Black



LB25 25mm W x 3mm thick
Ladder Back flat tape
Adhesive backed - White



BULK FIBREGLASS ROPE - SOFT / MEDIUM WEAVE



*10% Discount on order for 100m assorted
bulk fibreglass rope/tape*

Part No. Size Type

6025SP 6mm dia -in 25 metre lengths On Roll

9025SP 9mm dia -in 25 metre lengths On Roll

1225SP 12mm dia -in 25 metre lengths On Roll

1525SP 15mm dia -in 25 metre lengths On Roll

1925SP 19mm dia -in 25 metre lengths On Roll

2525SP 25mm dia -in 25 metre lengths On Roll

BULK ADHESIVE BACKED FIBREGLASS TAPE



Part No. Size Type

200325SP 19mm x 2mm -in 25 metre lengths
(only available on Spool) - Black On Spool

250325SP 25mm x 3mm -in 25 metre lengths
(only available on Spool) - Black On Spool

LB2530SP 25mm wide x 3mm thick Ladder
Back - White tape in 30m lengths On Roll

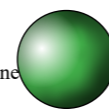



PYROGRIP®

STOVE & FIREPLACE ADHESIVE



Rated up to 1200°C

Part No. Size

1021 Squeeze Bottle, 200g



1022 Cartridge, 500g



FIREBRICKS

Part No. FB1
One Size - 230mm x 115mm x 25mm



Part No. FB1



GAS LIGHTERS & FIRELIGHTERS



Part No. OMLS4157-1
BBQ Gas Lighter
with 130mm long Bendable Neck
Refillable
Moulded Body



SUREBURN WATERPROOF FIRELIGHTERS

Part No.: SBFL

Made in
Australia



- Waterproof
- No smelly odours
- All natural
- Easy to light
- Environmentally friendly
- Non-toxic
- 24 snap-off blocks per pack

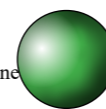



FUEL STOVE MAINTENANCE PRODUCTS

By Rubbed in



SOOT-LOOSE CHIMNEY & FLUE CLEANER

Rubbedin
Soot-Loose is
based on a non-

flammable, non-toxic, non-corrosive organic solvent which travels up the chimney/flue and dissolves tar and creosote. With regular use Soot-Loose will prevent the build-up of tar, creosote and soot in your chimney/flue, thus increasing the efficiency of your heater, reducing smoke emissions, and prevents dangerous flue fires. Unlike salt based flue cleaners Soot-Loose will not corrode stainless steel flues.

50g sachets, 3 x 50g sachet box, and 250g tins



HOT GLASS CLEANER

Rubbedin Hot Glass Cleaner has been designed to make light work of the stubborn soot, tar and creosote that accumulates on your wood heater glass. With continued use it

will reduce the build up of stains on your glass thereby making it easier to maintain. Hot Glass Cleaner is very easy to use, non hazardous and non-toxic It is also excellent at removing stubborn grease and food spills from combustion stove tops, oven and microwave doors, ceramic glass cooktops, and porcelain enamel.

200ml bottles.



CAST IRON STOVE POLISH

Rubbedin Cast Iron Stove Polish has been designed to restore that brand new, black satin finish to your cast iron stove and provide ongoing protection against flaking, rusting and pitting.

200ml bottles.



HI-TEMPERATURE POT-BELLY BLACK

Rubbedin High
Temperature Pot-Belly
Black is a high quality heat
resistant coating designed
to stop rust and restore that
brand new, satin black

finish to your potbelly stove, barbecue, oven, heater, flue and any other metal parts that are subject to heat. It is scientifically formulated to withstand heat up to 500°C and "NO PRIMER NEEDED."
250ml, 500ml tins and 350g spray cans.



HOT SPOT REDI-MORTAR

Rubbedin Hot Spot Redi-Mortar
is a heat resistant, sandstone
coloured, ready-to-use mortar
Because it can withstand heat

up to 1400°C it's ideal for use in installing and repairing fireplaces, chimneys, fuel stoves and barbecues. It is pre-mixed, simple to use, and air dries in 24 hours.

500g, 1 kg, 4kg, 35kg



BLACK PATCH STOVE PUTTY

Rubbedin black patch stove
putty is a black coloured
putty that resists heat
up to 1400°C It is ideal

for installing fibreglass rope or repairing fireplaces, chimneys/flues, fuel stoves and barbecues. It is pre-mixed, simple to use and air dries in 24 hours.

500g, 1 kg.



INSTANT BRICK

Rubbedin Instant Brick is a
heat resistant firebrick mix
specifically designed for
replacing and/ or repairing
fireplace bricks. It can with-

stand temperatures of up to 1000°C. It's simple to use, just add water, then dries overnight
4kg. tubs/pails.



FUEL STOVE MAINTENANCE PRODUCTS

By Rubbed in

Part No	Description	Barcode
0055	Soot Loose 50g Sachet	9312066042209
SL3PK	3 Pack of 50g Soot Loose sachets	9312066044166
1005	Soot Loose Chimney & Flue Cleaner - 250g	9312066041028
1002	Hot Glass Cleaner 200ml	9312066040021
1004	Cast Iron Stove Polish-200ml	9312066040014
RM500	Redi Mortar 500g tub (replaces RM400 - 400g)	9312066046238
1009	Redi Mortar 1kg	9312066042353
1209	Redi Mortar 4kg	9312066042506
1509	Redi Mortar 35kg - Made to order	9312066042438
5001	Black Patch Stove Putty- 500g tub (Replaces 4001 400g)	9312066042414
1015	Black Patch Stove Putty - 1kg	9312066042308
1617	Instant Brick - 4kg	9312066042513
	HI-T PAINT	
B0250	Pot Belly Black brush-on paint- - 250ml tin	9312066055155
1100	Pot Belly Black brush-on paint - - 500ml tin	9312066055117
1615	Pot Belly Black spray paint -350g spray can	9312066482449



(BSW) FLUE BRUSH KITS

- Kits includes –
- 4 off 900mm long screw together 8 gauge (4mm) twist wire handle
 - 1 x Brush head - ½” Whitworth fittings – no UA1 adaptor required
 - Kits are individually boxed



A) Kit With Polypropylene Brush Head

Part No	Size	Barcode
BSWPP04	4” dia x 3.66m (12ft)long	9323330000061
BSWPP045	4 ½” “	9323330000078
BSWPP05	5” “	9323330000085
BSWPP06	6” “	9323330000047
BSWPP07	7” “	9323330000092
BSWPP08	8” “	9323330000115

B) Kit With Gal Crimp Wire Brush Head

Part No	Size	Barcode
BSWSS04012	4” dia x 3.66m (12ft) long	9323330000108
BSWSS04512	4 ½ “ “	9323330000122
BSWSS05012	5” “	9323330000139
BSWSS06012	6” “	9323330000054
BSWSS07012	7” “	9323330000146
BSWSS08012	8” “	9323330000153

C) Twist Wire Rods Only – with ½” Whitworth Fittings

Part No	Description	Barcode
R9008G	8 gauge wire rod, 900mm long (as supplied in above kits)	9323330000160



(FF) FLEXI FLUE BRUSH KIT

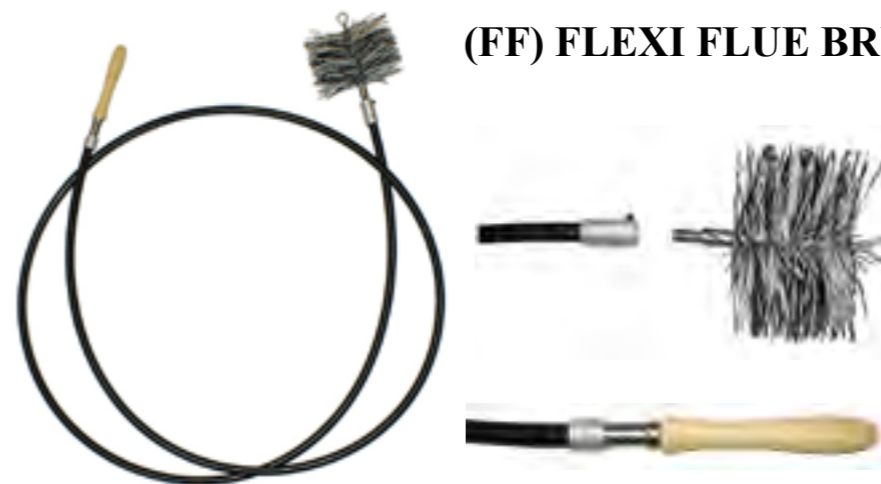

Flexi Flue Brush Kit
 Part No. **FFB-PP6-12**
 Consists of: Flexi Rod - 4 metre with wooden handle
 Brush Head - 150mm screw on, Nylon/Poly mix. for flexibility of brush bristles around tight bends

Part No	Description	Barcode
FFB-NY3-12	3" x 12' Flexi Flue Brush Kit	9323330000689
FFB-NY4-12	4" x 12' Flexi Flue Brush Kit	9323330000696
FFB-PP6-12	6" x 12' Flexi Flue Brush Kit	9323330000177
FFB-NY6-18	6" x 18' Flexi Flue Brush Kit	9323330000719
FFB-NY6-21	6" x 21' Flexi Flue Brush Kit	9323330000726
FFB-NY6-24	6" x 24' Flexi Flue Brush Kit	9323330000733
FFB-NY6-30	6" x 30' Flexi Flue Brush Kit	9323330000757
FFB-NY8-12	8" x 12' Flexi Flue Brush Kit	9323330000764

FFB-EX2NY	2 metre Flexi Extension	9323330000184
FFB-EX4NY	4 metre Flexi Extension	9323330000191

REPLACEMENT HEADS FOR (FF) FLEXI FLUE BRUSH KITS

Part No	Description	Barcode
FF04UA	Nylon/Poly mix– 4” dia	9323330000207
FF05UA	Nylon/Poly mix– 5” dia	9323330000214
FF06UA	Nylon/Poly mix– 6” dia	9323330000221
FF07UA	Nylon/Poly mix– 7” dia	9323330000238
FF08UA	Nylon/Poly mix– 8” dia	9323330000245



BRUSH HEADS TO SUIT (BSW) FLUE BRUSH KITS

D) Brush Heads Only – All With ½” Whitworth Fittings

Part No	Description	Barcode
PP4UA	Polypropylene – 4” dia	9323330000252
PP5UA	Polypropylene – 5” dia	9323330000269
PP6UA	Polypropylene – 6” dia	9323330000276
PP7UA	Polypropylene – 7” dia	9323330000283
PP8UA	Polypropylene – 8” dia	9323330000290
SSUA04	Gal Crimp Wire- 4” dia	9323330000306
SSUA045	Gal Crimp Wire- 4 ½” dia	9323330000320
SSUA05	Gal Crimp Wire- 5” dia	9323330000313
SSUA06	Gal Crimp Wire- 6” dia	9323330000337
SSUA07	Gal Crimp Wire- 7” dia	9323330000344
SSUA08	Gal Crimp Wire- 8” dia	9323330000351



BUSY BEE BRUSHWARE- POLYPROPYLENE PULL THRU ONLY FLUE BRUSHES

NOTE: Brush head lengths-200mm.

Mini pull- throughs have 100mm long heads.



PULL-THROUGHS (WITHOUT HANDLES)

Part No.	Description	Barcode
06MINIPP	6” dia mini-suit 45degree angle	9323330000030
08MINIPP	8” dia mini-suit 45degree angle	9323330000368
04012PT-PP	4” dia polypropylene only	9323330000375
04512PT-PP	4 ½” dia polypropylene only	9323330000382
05012PT-PP	5” dia polypropylene only	9323330000399
06012PT-PP	6” dia polypropylene only	9323330000023
08012PT-PP	8” dia polypropylene only	9323330000405
09012PT-PP	9” dia polypropylene only	9323330000412
10012PT-PP	10” dia polypropylene only	9323330000429

FLUE BRUSH WITH GALVANISED WIRE BRUSH HEADS BY BUSY BEE BRUSHWARE

PULL – THROUGHS (WITHOUT HANDLES)



Part No.	Description	Barcode
06MINISS	6” dia mini galvanized wire	9323330000436
08MINISS	8” dia mini galvanized wire	9323330000443
SS0040PT	4” dia galvanized wire	9323330000450
SS0045PT	4 ½” dia galvanized wire	9323330000467
SS0050PT	5” dia galvanized wire	9323330000474
SS0060PT	6” dia galvanized wire	9323330000481
SS0070PT	7” dia galvanized wire	9323330000498
SS0080PT	8” dia galvanized wire	9323330000504

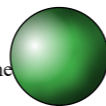



**RANGE OF PROFESSIONAL STRENGTH FLUE BRUSHES
FROM BUSY BEE BRUSHWARE**

Construction - 10mm x 2mm Steel Strap & Polypropylene.
Includes 1/2 " threaded fitting to suit UA 1 adaptor.

Note:

Please remember to order your Universal Adaptor P/N UA 1 with brush to connect to rod.
Also available on request is a lighter-density Polypropylene-for less strenuous jobs. Also POA

Part No.	Description	Barcode
PROF 6	6" dia - 150mm	9323330000634
PROF 8	8" dia - 200mm	9323330000511
PROF 10	10" dia - 250mm	9323330000528
PROF 12	12" dia - 300mm	9323330000535
PROF 14	14" dia - 350mm	9323330000542
PROF 16	16" dia - 400mm	9323330000559
PROF 18	18" dia - 450mm	9323330000566



PROFESSIONAL BRUSH
Sizes: 8" up to 18"

BELOW ITEM TO BE USED TOGETHER WITH ABOVE BRUSHES

Part No.	Description	Barcode
UA 1	Universal Adaptor 900mm (3ft) long- Rod x	9323330000573
R900	19mm dia (Polyethylene Tube)	9323330000580



**FIREPLACE ACCESSORIES
PREMIUM RANGE**



Part No: OF250BK
6 Bars
Size - 450 wide x 150 high x 285mm deep



Fire Grates - STEEL
Bars - Diamond Profile 27mm wide welded to Legs
Weight: 7.5kg

Part No: OF250BK-01
8 Bars
Size - 600 wide x 150 high x 285mm deep
Weight: 9.45kg



Part No: OF250BK-03
8 Bars
Size - 750 wide x 150 high x 285mm deep
Weight: 10.75kg



Part No: OF08010NC
Bellows -43cm Long x 19 cm wide 3.5cm deep
with silver coloured trim



Part No: OF20000BK
Black 2 Pce Floor Set
Includes- Tampico Heat resistant
Brush, Shovel plus Floorstand
36.5cm overall length (approx)





FIREPLACE ACCESSORIES PREMIUM RANGE

Dimensions are approximate

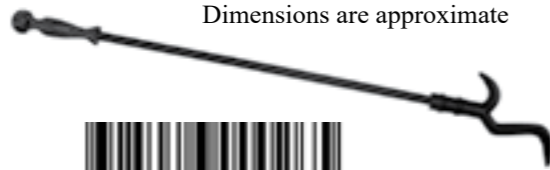

Part No. BR02P(Black)
Poker - Cast Iron
Size: 69cm long
Weight:- .8kg



9 325086 000265



Part No. OFSCR-01
Scraper - All Black
Size: 69cm long



9 325086 008421

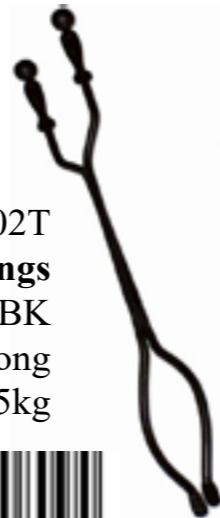

Part No. BR02T
All Black Cast Iron Tongs
As supplied in tool set BR02BK
Size: 69cm long
Weight:- 1.5kg



9 325086 008094



Tongs Scissor Action
Part No. OFFTA07B
70cm L x 8.5cm W x 6cm H
Black 0.9kg weight



9 325086 013487



FIRE SHOVELS, HEARTH BRUSH



Part No. OF1023
Fire Shovel - Wide
• Black painted fire shovel, metal handle
• Blade width - 180mm
• Handle length - 180mm



9 325086 007080



Part No. CH005SH
Fire Shovel
• Black painted fire shovel, metal handle
• Blade width - 11.5cm W x 16.5cm L
• Handle length - 18.5cm



9 325086 009756



Part No. CH005BR
Hearth Brush
• Brush - 28cm O/A length,
• Heat resistant fibre



9 325086 009749



Part No. CH005MS
Hearth Brush Set
• Brush - 28cm O/A length,
• Heat resistant fibre
• Shovel - 11.5cm W x 16.5cm L blade,
plus 18.5cm L steel handle



9 325086 009633





GAL BUCKET (RIMLESS)



Part No. GALBUCM

- Type Medium (10 litre)
- Size: 225mm H x 275mm dia top x 195mm dia bottom



Gal Bucket / Shovel / Brush Combo

Part No. GBFSHB

Comprises:-

- Part No. GALBUCM - as above
- Part No. CH005SH - Fireshovel
- Part No. CH005BR - Brush



WOOD HEATER STARTER KIT



INCLUDES:

- Wood Sling
Easily carry wood and kindling to your wood heater.
Folds when not in use. Black woven polyester.
- Sureburn Firelighters - 24 Snap-off block
All natural - Quick to light - No smell - Waterproof.
Made in Australia.
- Soot Loose - 2 x 50g sachets
With regular use Soot-Loose will prevent the build-up of tar, creosote and soot in your chimney/flue.
Made in Australia.
- Woodheater Door Glass Cleaner - 2 pack
Fast effective dry cleaning - use without using any extra cleaning agent.
Made in Germany.

Part No. WHSTKT

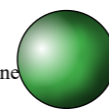



Digital Moisture Meter

Part No. DGMMTR

- Built-in Auto Power Off
- Electrode Pins - Integrated
- Display Wood Moisture LED
- 4 Calibrated wood group selections
- Measurement Principle - Electrical Resistance



Leather Fire/Flame Resistant Gauntlets - Pair

Part No. LEFIGA

- 400mm long
- Fully Lined
- Kevlar Thread Sewn
- Yellow - Fully welded seams



Heat Powered

Radiant Wood Heater Fan

- Fast starting temperature as low as 50°C
- Maximizes heat, with possible fuel savings
- Self-powered by heat, no running costs
- Quiet operation
- Suitable for any radiant wood heaters/wood stoves.



For Warm Homes

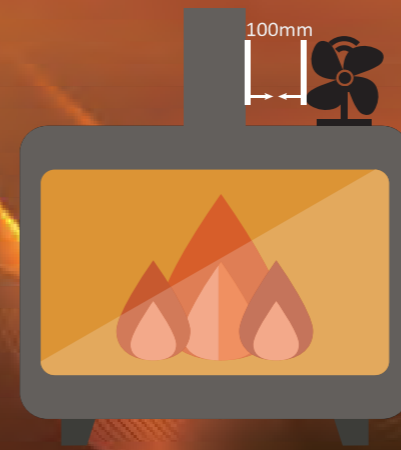

Minimum 100mm away from heater/stove flue if possible
 Keep away from heat vents on heater/stove top if any
 Do not position in front of chimney/flue

- Increases efficiency, circulates warm air throughout the room
- Creates its own electricity, no running cost
- Fast starting at temperature as low as 50°C
- Maximum operating temperature 350°C
- Optimum operating temperature: 80~250°C
- Maximum air flow: blows up to 100m/minute
- Running RPM:>900 RPM
- May reduce emissions by burning less fuel
- Inbuilt protection system to stop the fan overheating
- Quiet operation, the noise<25db
- Easy to install, place on a flat surface, 100mm away from flue
- Suitable for any radiant wood heater/wood stove.

Product Details:

Part No. HPSF1

Material: Anodized Aluminum
 Height (including blade): 189mm
 Width (including blade): 180mm
 Base Dimension: 110*75mm
 Weight: 540g
 Warranty: 12 Months

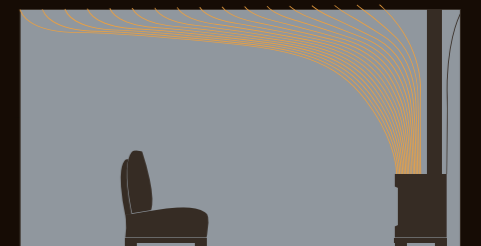

Heat Distribution Without *Heater Fan*

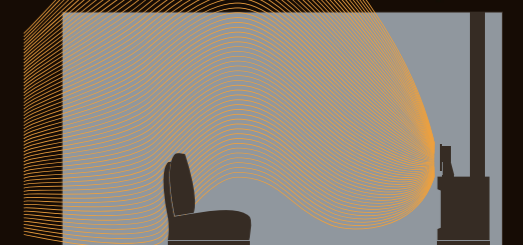

Heat Distribution With *Heater Fan*



Part No: HPSF1

Distributed by: S & D Berg Trading Pty Ltd, Vic, Australia

CHILD GUARDS



UNIVERSAL CHILD GUARD

Easily fold up for storage & for carrying

Comprises 6 off 60cm wide 74cm H panels incl. gate panel -as pictured, Child Guard 120cm W x 120cm D x 74cm H Weight: 11.6kg



Part No. UNIGUARD



Long Front Panel with Gate

Excess Panels can easily be removed



Ideal as Room Divider or Stairway Protector

60cm Wide Extension Panel Part No. UNIGUARDEXT



Hexagonal shape



Use as Playpen or restrain small animals (Puppies etc)

Gate on side panel

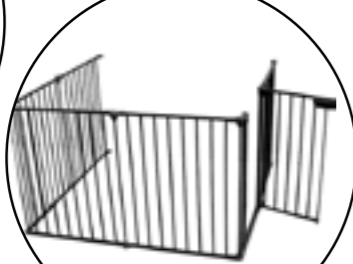

Reposition panels as required to suit heater door opening

Gate on Left Hand front panel

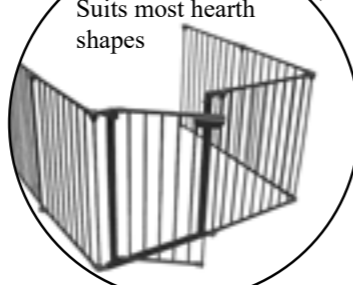

Suits most hearth shapes

Gate Section Panel Only



Part No. UNIGUARDG



Child Guards with Gate

2 FREE STANDING SIZES PLUS CORNER AND INBUILT

Part No: OFGT110-2

Child Guard with Gate

- 110 x 110 x 80cm high
- Weight: 15.0kg



Part No: OFGT125-2

Child Guard with Gate - Large

- 125 x 125 x 80cm high
- Weight: 17.0kg



- Black Powder Coated Steel.
- Extra Heavy Duty Steel Frame.
- Frame - 12 x 25mm rectangular tubular steel
- Vertical Bars - 5mm dia with 35mm gaps between each.
- Gate opens from either side - remove hinge pin in front panel to allow easy access to heater.
- Comprises - 3 panels, easy to erect and dismantle for storage.
- Includes wall mount fixing kit and 2 spreader bars (If fixing to wall is not suitable).

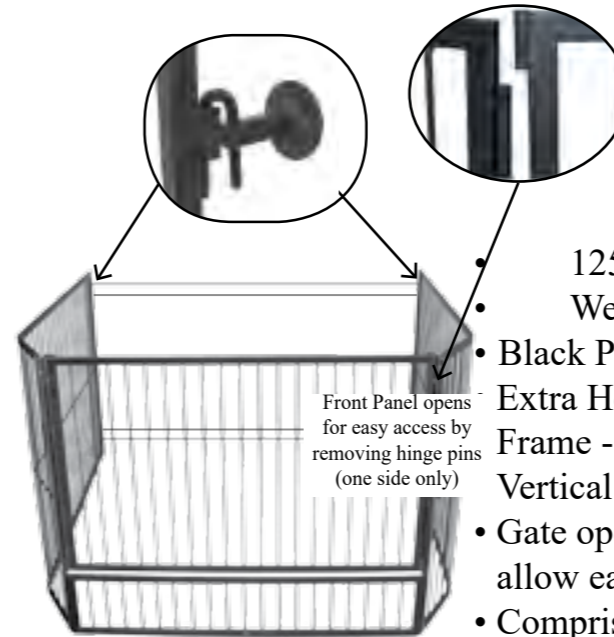

OFGTCNR Hearth Size for On and Off the Hearth

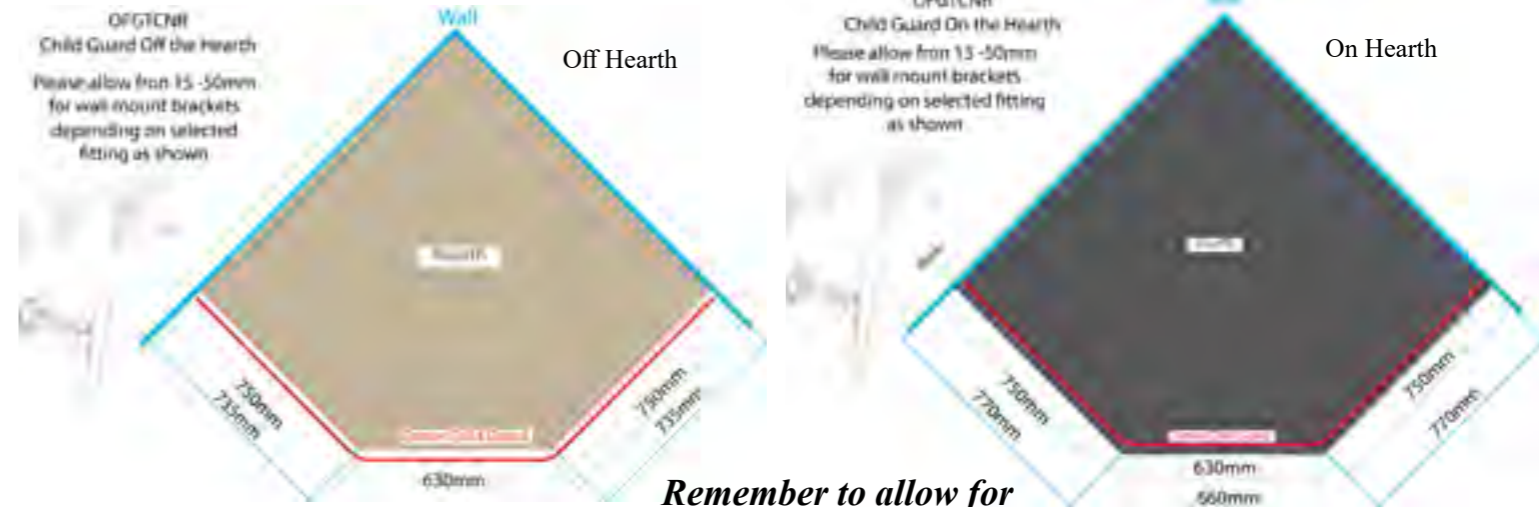

Remember to allow for Wall Mount Fittings



Child Guards with Gate

Front Panel opens for easy access by removing hinge pins (one side only)

Part No: OFGTCNR-2

Child Guard with Gate - Corner Type

- Black Powder Coated Steel.
- Extra Heavy Duty Steel Frame.
- Gate opens from either side - remove hinge pin in front panel to allow easy access to heater, (when fixed to wall).
- Comprises - 3 panels, easy to erect and dismantle for storage.
- Includes wall mount fixing kit.
- Size - 175cm wide at rear x 75cm deep x 79.5cm high.
- Frame - 12 x 25mm rectangular tubular steel
- Vertical Bars - 5mm dia with 35mm gaps between each.
- Weight: 10.5kg

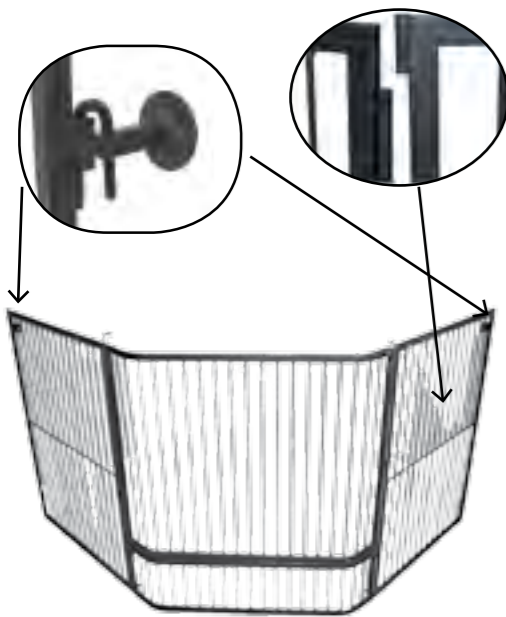

30cm deep

Front Panel opens for easy access by removing hinge pins (one side only)

Part No. OFGTIB-2
CHILD GUARD WITH GATE
For Inbuilt Heater

125cm x 30cm deep x 80cm high.

Frame - 12 x 25mm rectangular tubular steel
Vertical Rods - 5mm dia with 35mm gaps between each.
Weight: 10.0kg



Clips for wall fixing - Alternative Fitting

- Black Powder Coated Steel.
- Extra Heavy Duty Steel Frame. Vertical bars only 35mm apart.
- Gate opens from either side - remove hinge pin in front panel to allow easy access to heater.
- Comprises - 3 panels, easy to erect and dismantle for storage.
- Wall mount brackets included.



Mesh Child Guards with Gate

5 FREE STANDING SIZES

Part No: OFGT110MSH-2
Mesh Child Guard with Gate

- 110 x 110 x 80cm high
- Weight: 12.5kg



Keep Your Family Safe

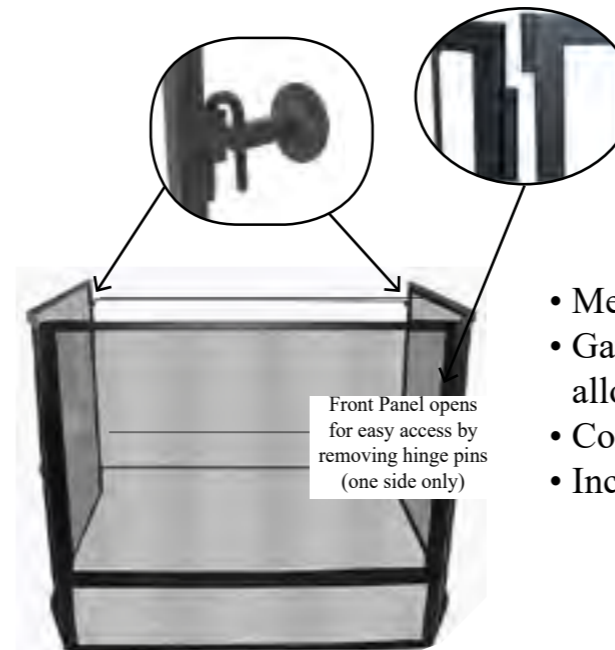

Front Panel opens for easy access by removing hinge pins (one side only)

- Black Powder Coated Steel.
- Extra Heavy Duty Steel Frame.
- Frame - 12 x 25mm rectangular tubular steel
- Mesh - fitted in each panel.
- Gate opens from either side - remove hinge pin in front panel to allow easy access to heater.
- Comprises - 3 panels, easy to erect and dismantle for storage.
- Includes wall mount fixing kit and 2 spreader bars (If fixing to wall is not suitable).

Part No: OFGT95MSH-2
Mesh Child Guard with Gate

- 95 x 95 x 80cm high
- Weight: 10.8kg



Part No: OFGT125MSH-2
Mesh Child Guard with Gate - Large

- 125 x 125 x 80cm high
- Weight: 13.5kg





Mesh Child Guards with Gate

2 CORNER SIZES



Heavy Duty Mesh fitted between main frame and welded strip at rear - on all 4 guards on this page.

Front Panel opens for easy access by removing hinge pins (one side only)

Part No: OFGTCNRLGMSH-2

Mesh Child Guard with Gate - Corner Type Large

- Size - 189cm wide at rear x 94cm deep x 80cm high.
- Weight: 10.0kg

**Fits Around Large Corner Hearths
92cm L wings & 42cm L front**



9 325086 013876

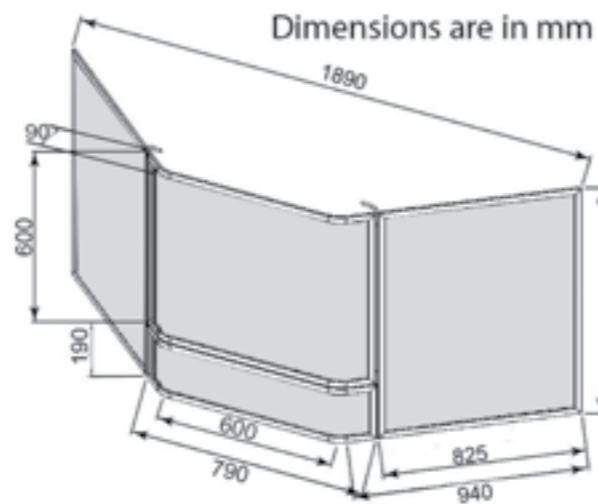

Dimensions are in mm

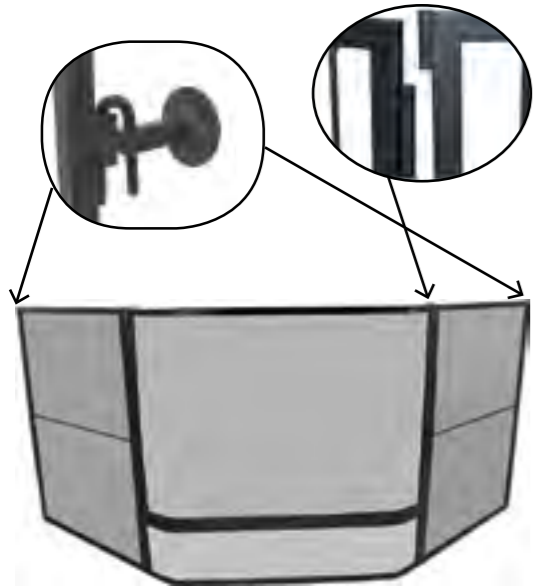

**Part No: OFGTCNRMSH-2
Mesh Child Guard with Gate
- Corner Type**

- Size - 175cm wide at rear x 75cm deep x 79.5cm high.
- Weight: 9.0kg



9 325086 012169

- Black Powder Coated Steel.
- Extra Heavy Duty Steel Frame.
- Gate opens from either side - remove hinge pin in front panel to allow easy access to heater, (when fixed to wall).
- Comprises - 3 panels, easy to erect and dismantle for storage.
- Includes wall mount fixing kit.
- Frame - 12 x 25mm rectangular tubular steel
- Mesh - fitted in each panel

INFORMATION

OFGTCNRLGMSH-2 Corner Child Guard LARGE

Note:

The positioning of the Child Guard around the hearth may vary depending on:

1. If there is a skirting board around the wall.
2. Fitting of wall brackets. (see extra information on wall bracket fitting, below.)
3. Squareness of the walls. If the walls in the corner are out of square and the hearth is fitted to one wall the measurements around the hearth will vary.

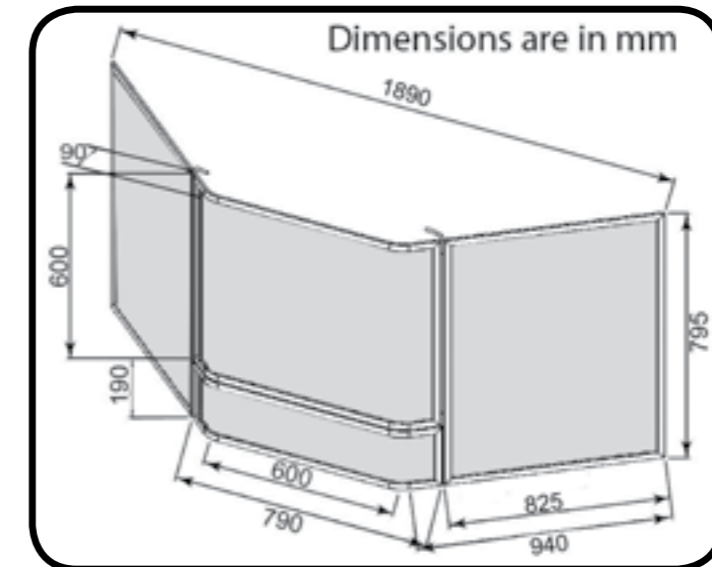

Dimensions are in mm

Sizes may be + or -

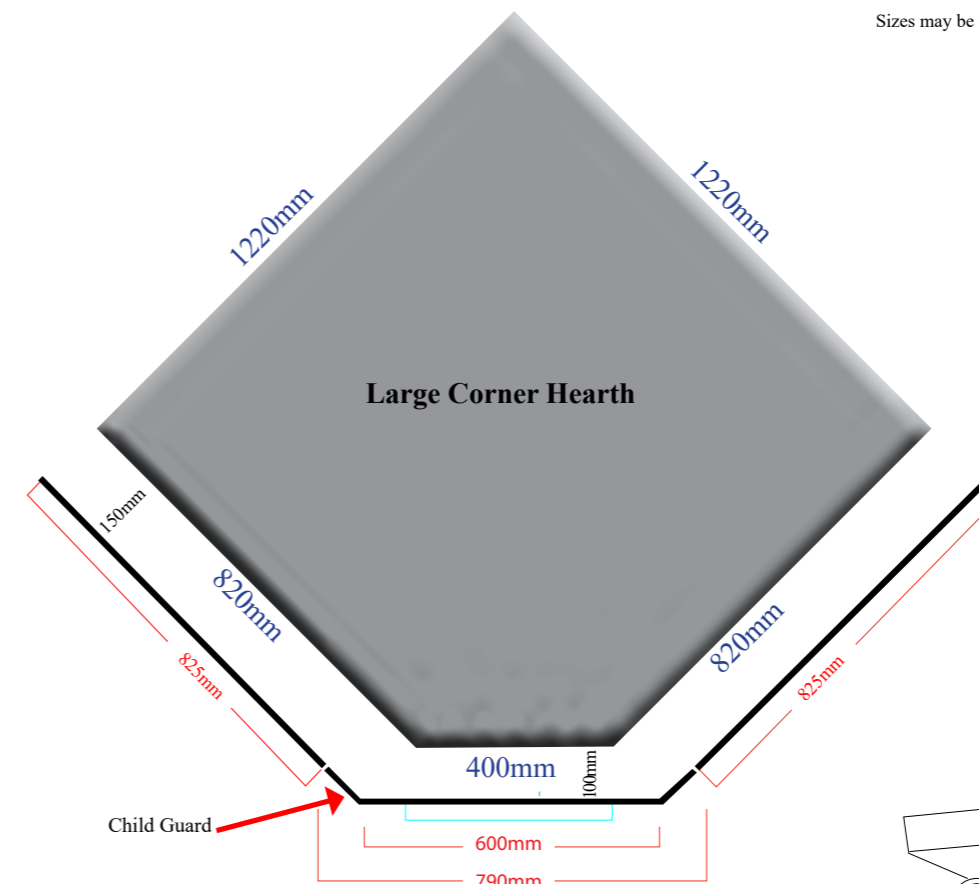

Large Corner Hearth

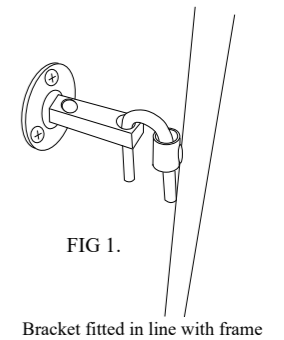

FIG 1.

Bracket fitted in line with frame

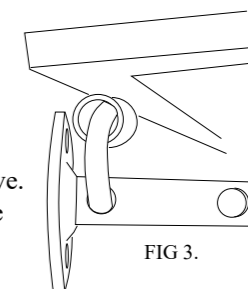

FIG 3.
Bracket fitted inside frame using alternative hole

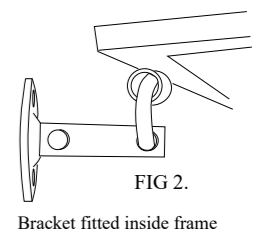

FIG 2.
Bracket fitted inside frame

Wall Mount Positioning:

The wall bracket may have to be fitted depending on the scenario mentioned above.

1. Fitted to the wall directly in line with the frame (Fig 1.)- Allow 55mm from the wall
2. Fitted to the wall inside the frame (Fig 2.)- Allow 30- 40mm from the wall
3. Fitted to the wall inside the frame using alternative hole (Fig3)
- Allow 15mm from the wall



Mesh Child Guards with Gate



Heavy Duty Mesh fitted between main frame and welded strip at rear - on all 4 guards on this page.

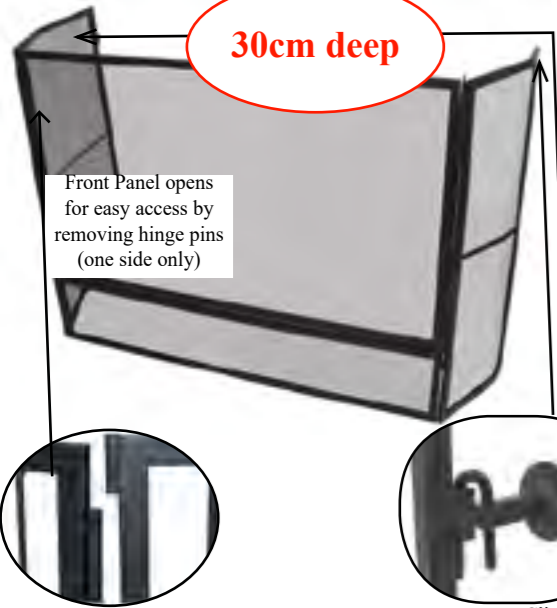

Part No. OFGTIBMSH-2
Mesh Child Guard With Gate
For Inbuilt Heater



- Size - 125cm x 30cm deep x 80cm high.
- Frame - 12 X 25mm rectangular tubular steel
- Mesh - fitted in each panel
- Weight: 9.0kg

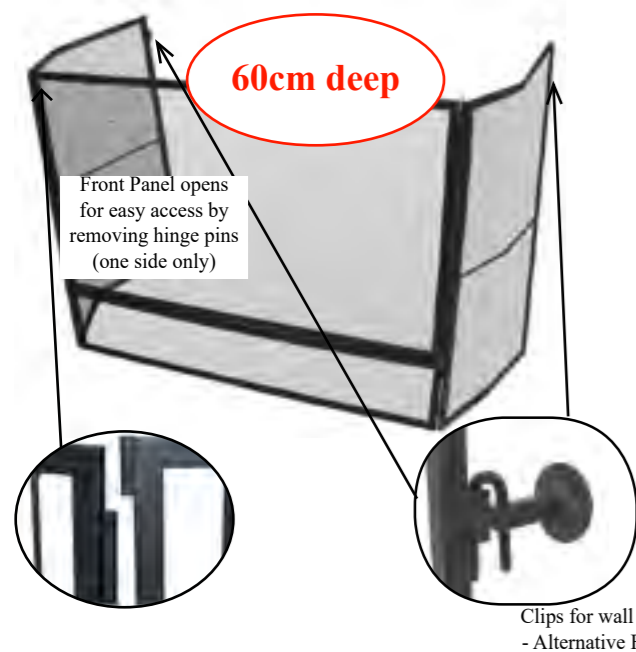

Part No. OFGTIBLGMSH-2

Suits Inbuilt Heaters with 50cm deep Hearths

- Size - 125cm x 60cm deep x 80cm high.
- Frame - 12 x 25mm rectangular tubular steel
- Mesh - fitted in each panel
- Weight: 10.3kg



INFORMATION

OFGTIBLGMSH In Built Child Guard - LARGE

Note:

The positioning of the Child Guard around the hearth may vary depending on:

1. If there is a skirting board around the wall.
2. Fitting of wall brackets. (see extra information on wall bracket fitting, below.)
3. Squareness of the walls. If the walls in the corner are out of square and the hearth is fitted to one wall the measurements around the hearth will vary.



Because the wings are hinged - you can alter the measurements at the rear
 Note: Wings at right angle to the front panel will be 1250mm at the rear

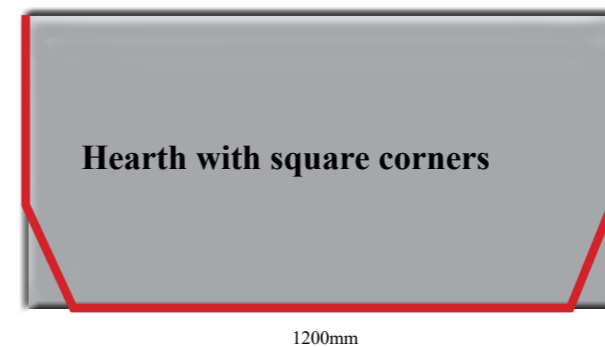
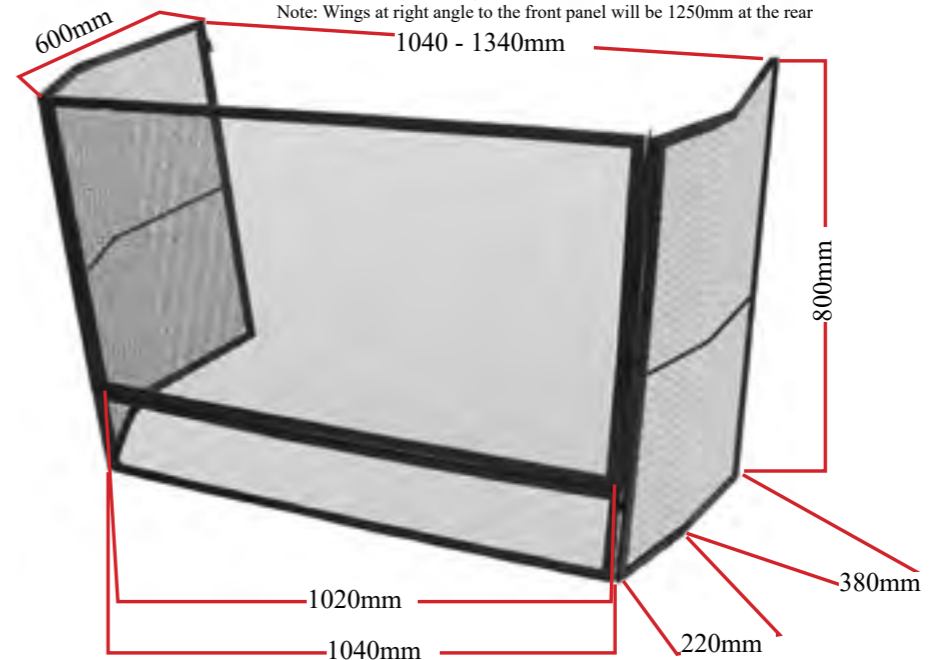

Represents Child Guard

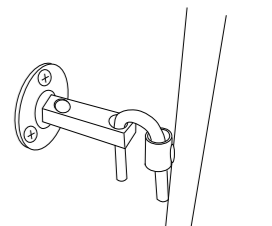

FIG 1.
Bracket fitted in line with frame

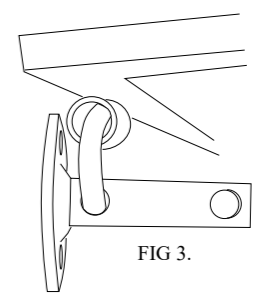

FIG 3.
Bracket fitted inside frame using alternative hole

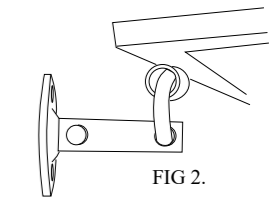

FIG 2.
Bracket fitted inside frame

Wall Mount Positioning:

The wall bracket may have to be fitted depending on the scenario mentioned above.

1. Fitted to the wall directly in line with the frame (Fig 1.)- Allow 55mm from the wall
2. Fitted to the wall inside the frame (Fig 2.)- Allow 30- 40mm from the wall
3. Fitted to the wall inside the frame using alternative hole (Fig3) - Allow 15mm from the wall



FIRE SCREENS



FIRE SCREENS- PREMIUM

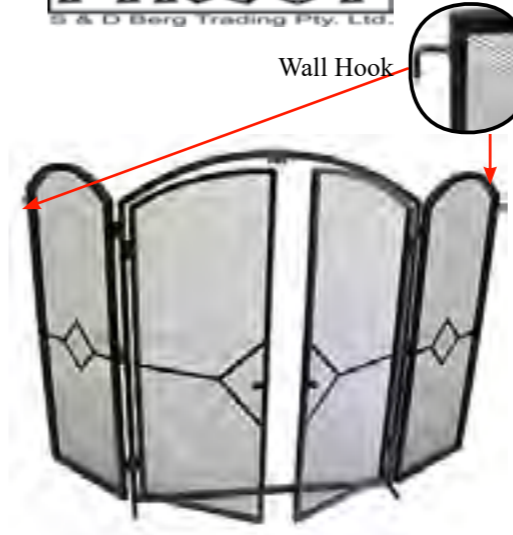

Fire Screen with Gate
Part No: OF38510
 Deco Styling - 3 Fold Fire Screen with Gate
 Convenience of opening gate to access fireplace.
 Black Heavy Duty Mesh
 Fitted between main frame and welded support strips at rear
 Black Square Tube Frame
 Fully welded construction
 Front Panel: - 64cm wide (incl. 2 gates) x 79cm high.
 Wings: - each 29.5cm wide x 79cm high.
 Weight: 6.5kg

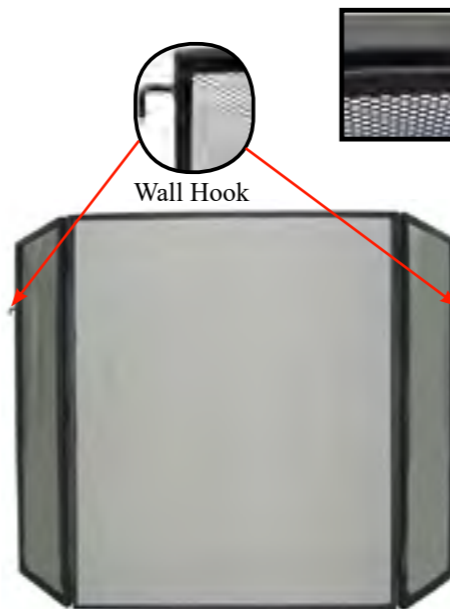

Mesh fitted between main frame and welded strip at rear

Fire Screen
Part No: OF38227BK
 3 Fold Fire Screen
 Black Heavy Duty Mesh
 Fitted between main frame and welded support strips at rear
 Black Square Tube Frame
 Fully welded construction
 Front Panel: - 65cm wide x 79cm high.
 2 Wings: - each 31cm wide x 79cm high.
 Weight: 4.5kg

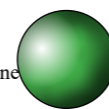



FIRESCREENS - PREMIUM RANGE



Mesh fitted between main frame and welded back strip

Sloping Fire Screen - Fixed Wing

Part No: OF060802BK

- Black Steel Frame
Fully Welded Construction
- Heavy Duty Mesh
Mesh is fitted between main frame and welded support strip at rear

Size: Front Panel - 90cm wide x 65cm high (approx)
Weight: 3.8kg



FIRESCREENS - PREMIUM RANGE

PATTERN DESIGN



Mesh fitted between main frame and welded strip at rear
On both Pattern and Leaf Design screens

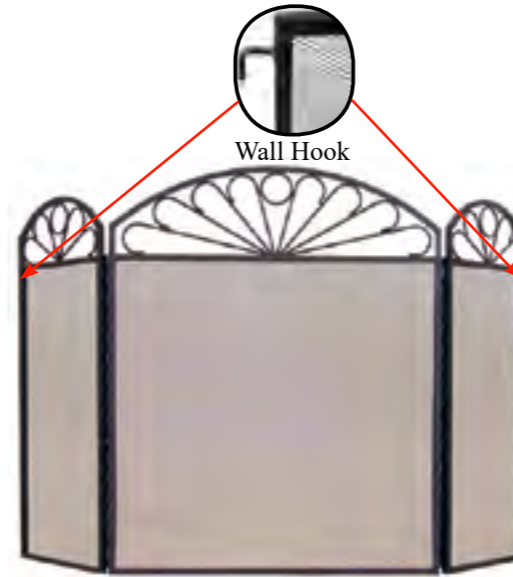

Wall Hook

Part No OFTB31208BK

3 Fold Pattern Firescreen.

- Black Square Tubular Frame
Fully Welded Construction
- Heavy Duty Mesh
fitted between main frame and welded support strip at rear

Front Panel - 66cm wide x 84cm high
2 Wings - each 31.5cm wide x 79.5cm high
Frame - 12 x 12mm tubular steel
Screen weight 6.5kg



LEAF DESIGN



Part No OF38224BK-01

3 Fold Firescreen with Leaf Design

- Black Square Tubular Frame
Fully Welded Construction
- Heavy Duty Mesh
Mesh is fitted between main frame and welded support strip at rear

Front Panel - 65cm wide x 79cm high
2 Wings - each 31 cm wide x 79cm high
Overall weight - 6.0 kg





FIRESCREENS - PREMIUM RANGE

ANTIQUE BRASS DESIGN



Firescreen, Ornate 3 fold. Cast iron Ornate top frame

Part No. OFS39040AB
Brass Plated & Black
82cm H x 127cm W total
6.5kg nett weight



FIRESCREENS - ECONOMY RANGE

Dimensions are approximate



Part No. FP3B-02
3 Fold
- Black
Front Panel - 66cm W x 77cm H
Wings - 2 each 32cm W x 77cm H
Weight: 2.5kg



Part No. FP3NP-03
3 Fold
- Black with Nickel plated top frame
Front Panel - 66cm W x 77cm H
Wings - 2 each 32cm W x 77cm H
Weight: 2.9kg



Part No. FP4B
4 Fold - Black
77cm H x 33cm W panels x 4
Weight: 3.5kg





FIRE TOOLS



TONGIO FORGING STANDARD RANGE



3 Piece plus Stand
Part No. BU3
 - Log Roller
 - Wide Shovel
 - Angled Brush
 - Stand, 72cm high
 Tools 8mm dia shafts
 Stand 10mm dia shaft
 Weight: 2.0kg



4 Piece plus Stand
Part No BU4
 - Scraper
 - Log Roller
 - Wide Shovel
 - Angled Brush
 - Stand, 72cm high
 Tools 8mm dia shafts
 Stand 10mm dia shaft
 Weight: 2.4kg



4 Piece plus Stand
Part No. BU4T
 - Tongs
 - Log Roller
 - Wide Shovel
 - Angled Brush
 - Stand, 72cm high
 Tools 8mm dia shafts
 Stand 10mm dia shaft
 Weight: 2.5kg



*Carton quantity Cost - 1 carton comprises 4 assorted tool sets.
 Can assort with BU Series/TE Series/WTE Series and Riviera Series sets.
 Can Have: 1 of one model, 3 of another model or 2 each of 2 models or 4 of one model or one of each of 4 models*



Display box for each set or firetools



TONGIO FORGING STANDARD RANGE



Rake
Part No. BURK
560mm long

Tongs
Part No. BUTG
510mm long



TONGIO FORGING - INDIVIDUAL TOOLS HAND FORGED

Part No.:WELR
Log Roller (Poker with Barb)
- Wooden Handle



Part No.:WESR
Scraper
- Wooden Handle
Size: 520mm Long



Part No: RLR
Log Roller (Poker with Barb)
- Riviera Series
Size: 555mm Long



TONGIO FORGING DELUXE RANGE

HAND FORGED STEEL HANDLES



Weight: 2.64kg



Part No. TE3LA
3 pce + Stand
Wide Shovel
Log Roller
Angled Brush



Weight: 3.4kg



Part No. TE4TLA
4 pce + Stand
Shovel
Tongs
Log Roller
Angled Brush



Weight: 3.5kg



Part No. TE4LA
4 pce + Stand
Wide Shovel
Scraper
Log Roller
Angled Brush

All Sets

72cm overall height. 14mm dia shaft on stand, 10mm dia shaft on tools

Dimensions are approximate

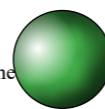



TONGIO FORGING - DELUXE RANGE

HAND FORGED TIMBER HANDLES



Weight: 2.6kg



Part No. WTE3LA

3 pce + Stand
Wide Shovel
Log Roller
Angled Brush



Weight: 3.3kg



Part No. WTE4LA

4 pce + Stand
Wide Shovel
Scraper
Log Roller
Angled Brush

All Sets

72cm overall height. 14mm dia shaft on stand, 10mm dia shaft on tools

Dimensions are approximate



TONGIO FORGING RIVIERA SERIES

PREMIUM RANGE HAND FORGED



Part No. RIV3
3 Piece plus Stand
Log roller, wide
shovel, angled brush.
Weight: 4.2kg



All this series
packaged in individual cartons



Part No. RIV4
4 Piece plus Stand
Log roller, wide shovel,
angled brush, rake
Weight: 4.5kg



All Riviera Sets

75cm overall height. 16mm dia chunky shaft on stand, 12mm dia chunky shaft on tools
-(compared with 10mm on TE/WTE series)

Tool length: Brush and shovel 49cm, Log Roller, rake and scraper 56cm





FIRETOOL SETS - MID RANGE

All Firetool Sets have heat resistant Fibre brushes

NOTE:-
*“Pewter Finish” is Nickel Plating

Part No: HB902SB

Fire Tool Set with Curved Stand

Stainless Steel & Black Metal Frame

Stand: 66cm high. - Base: 21.5cm dia

Includes:

Coco Fibre Heat Resistant Brush

Poker - Tongs - Shovel

Weight: 2.5kg



Part No. BR02BK

(Black)

4 pce + stand

Heavy Duty Classic

Size: 77cm H

Weight 5.5kg.



Part No. BR02NP

(Black/Pewter Finish)

4 pce + stand

Heavy Duty Classic

Size: 77cm H

Weight 5.5kg.



Part No. BR02PK

Black/Brass Plated

4 pce + stand - Heavy Duty Classic

Size: 77cm H

Weight 5.5kg.



Part No. BR10NP

4 pce + Stand

Black/Pewter* finish

Size: 64cm H

Weight 4.5kg.



Part No:BR10BK

Firetool Set

4 pce + stand

Black finish

Size: 64cm H

Weight 4.5kg.



Part No. BR13BK

4 pce + stand

Black with

scraper

Size: 57cm H

Weight 3.6kg.



Part No. BR10PK

4 pce + stand

Black finish with Brass trim

Size: 64cm H

Weight 4.5kg.



FIRETOOL SETS - MID RANGE

All Firetool Sets have heat resistant Fibre brushes





FIRE TOOL SETS - ECONOMY RANGE

Part No. OFT14033BK
 Firetool Set, 3 Pce + Stand
 56cmH, Black
 Poker, Shovel, Heat resistant Brush



Part No. FP235
 3 piece plus stand
 60cm high
 Black
 Weight: 2.2kg



Part No. FP22B
 3 Piece plus stand
 72cm high - Black
 Weight: 3.2kg



FIRE TOOL SETS

Part No. FP234
 3 piece plus stand
 60cm high
 Black with Brass
 plated handles
 Weight: 2.2kg



Part No. OFFT29HS
4 piece Fire Tools Set in Bucket Stand
 Bucket - Stainless Steel
 • 16cm dia x 35cm high
4 Stainless Steel Tools
 • Brush 54.5cm L - Head 11cm x 3.5cm
 • Shovel - 52.5cm L - Head 11.2cm wide
 • Poker - 52cm L
 • Tongs - 51cm L



Part No. HB011SG
Firetool Set 4 pce plus Stand
 Stainless Steel and Grey
Stand Height: 66 cm long (approx)
Includes:
 Coco Fibre Heat Resistant Brush
 Poker - Tongs - Shovel
Weight: 2.2kg

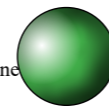



Firetool Set 3 Pce plus Stand
Part No. FP236SNP
72cm H,
Black with Nickel Plated Handles
Includes Shovel, Brush and Scraper



Wall mounted 4 Pce Firetool Set
Part No. OFT40001BK
Black Finish.
Tools 53cm L - Poker, Heat Resistant Brush, Shovel, Tongs
Wall mount plate - 40cm L x 4cm H x 0.5mm thick steel



WOOD CARRIERS

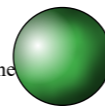



WOOD CARRIERS AND STORAGE



Part No: OFAP9013BK
Wood Ring with Tray

61cm dia x 70cm H
10mm square solid steel frame
Tray 60 x 40cm
Weight: 5.3kg
Effective way to stack wood indoors
Large capacity & easy horizontal load/unload
Supplied in knockdown form
- easy to assemble & disassemble - Black Finish



Part No. OFW1881AT
Wood Ring XL with chip tray
100cm dia x 109cm high 38cm deep at base
Suits Wood 40cm L - minimum
Chip tray 102cm x 38cm x 0.06mm thick steel
Frame - 19mm steel tube
150kg wood storage capacity



Part No. HB149B2

• Log Holder - Wood Sling & Cradle
• Use the Wood Sling to carry wood indoors.
• Cradle to store wood alongside fire in the Wood Sling
• Wood Sling - 420D polyester with carry handles.
• Storage Cradle - 20 x 20cm heavy duty square steel tube,
- easy to assemble
Unloaded Weight: 3.0kg



WOOD CARRIERS



2 Tier Wood Rack with Firetools

Black Metal Frame.
Part No. OFFT99B
2 Tier Storage.
Size: 45cm W x 30cm D x 73cm H.
Includes 4 Firetools - poker, brush, shovel, tongs.
Weight: 8.8kg



Premium FireWood Cart
Part No. PFWDCART
All Black
60kg Capacity
Made from 2.0mm steel plate
Top Tray for kindling or firewood
Fitted with heavy duty wheels.
Size: 36 w x 41 d x 87.5cm high
Top Tray: 67cm above bottom tray



Part No. OFFT99BNT
2 Tier Wood Rack XL - Without Tools

Black Metal Frame.
2 Tier Storage.
Size: 55cm W x 55cm D x 92cm H.
Compared with 2 Tier Wood Rack w/ Tools
Part No. OFFT99B - 45cm W x 30cm D x 73cm H
I.e. 1.8 times larger storage capacity for OFFT99BNT



Large 2 Tier Wood Rack with Firetools

Black Metal Frame.
Part No. OFFT99VL
Size: 55cm W x 45cm D x 72cm H.
Includes 4 Firetools - poker, brush, shovel, tongs.

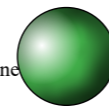



WOOD BUCKETS

POWDER COATED
MATT FINISH

TAPERED BUCKET

Dia - 435/365mm top
- 230mm bottom
Depth - 380mm
Finish - **Black**

Part No. TBLHT
Small Tapered, Black



9 325086 000029



LARGE TAPERED BUCKET

Dia - 470/380mm top
- 310mm bottom
Depth - 490mm
Finishes - **Black**
- **Dark Grey**

Part No. LTGYHT
Large Tapered, Dark Grey



9 325086 006274



ROUND BUCKET

Dia - 360/370mm
Depth - 390mm
Finishes - **Black with Gold or Silver band**
- **Dark Grey with silver band**

Part No. BLHT
Round Black Gold Band



9 325086 000050



Part No. BSHT
Round Black Silver Band



9 325086 011377



Part No. GYHT
Round Dark Grey Bucket



9 325086 006267

*Note: Dark Grey to suit dark grey heater finish
Dimensions are approximate*



WOOD BINS

POWDER COATED
MATT FINISH



Part No. WDBN
Woodbin, Rectangular - Black

WOODBIN

Size: 500mm L x 380mm W x 300mm H
rectangular



9 325086 001903



Part No. GYBN
Woodbin, Rectangular - Dark Grey

*Note: Dark Grey to suit dark grey heater finish
Dimensions are approximate*



9 325086 006281

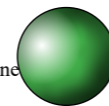

OUTDOOR WOOD RACK



Part No. OFT108XL
Wood Box Collapsible

- Extra Large
 - Heavy duty steel
 - Black
 - Collapses, for easy storage when not in use.
 - 50cm W x 50cm D x 50cm H
- Weight: 8.5kg



Part No. OFNIODWR
Outdoor Wood Rack

Size: 152cm L x 35.5cm D x 122cm high
Black Powder Coated Steel Frame
25mm dia x 1.2mm wall thickness
500kg Capacity



WOOD SLING & WOOD TOTE BAG



Great for: • Wood • Kindling • Garden Waste
Part No OFWSLG



Polybag
Hang sell
display pack

Folded
(for wood carrying)



Open Flat
(for Garden etc)



Firewood



- Light Weight • Rugged Construction • Easily Stored.
- Little Effort • No Mess.
- When not being used to carry wood, excellent for use in the garden to kneel on.
- Black Woven Polyester.
- Polybag - hang sell display pack.
- Size approx: - 785mm when open plus handles and 385mm folded.



Part No. OFNIWTBG
Wood Tote Bag

92.7cm x 45.7cm (when flat)
Handles 14cm H
Material Canvas Bag and handles
50kg capacity

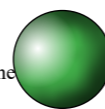



WOOD FIRED PIZZA OVEN TOOLS



Part No	Description
PZERPC	Embers Rake/Scraper - 750mm long handle, food grade black powder coated steel Barcode: 9325086013005
PZERSS	Embers Rake/Scraper - 750mm long handle, 304 stainless steel Barcode: 9325086013012
PZSHPC	Shovel - 750mm long handle, food grade black powder coated steel Barcode: 9325086013029
PZSHSS	Shovel - 750mm long handle, 304 stainless steel Barcode: 9325086013036
PZBSPC	Brush, natural fibre bristles, 750mm long handle, food grade black powder coated steel Barcode: 9325086013043
PZBSSS	Brush, natural fibre bristles, 750mm long handle, 304 stainless steel Barcode: 9325086013104
Wall mount set - 750mm x 8mm dia L handle rake/shovel/brush plus 3 pc wall mount bracket, food grade stainless steel or black powder coated steel Includes 4- 35mm x 10g SS screws and wall plugs Rack - 600mm wide x 75mm high	
PZWBPC	Black Powder Coated Barcode: 9325086013050
PZWBSS	Stainless Steel Barcode: 9325086013067

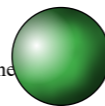



Floor mount set - 750mm L handle rake/shovel/brush plus 3 pc floor mount stand, food grade black powder coated steel or Stainless Steel



Part No	Description
PZFSPC	Black powder coated steel Barcode: 9325086013074
PZFSSS	304 stainless steel Barcode: 9325086013081

Part No	Description
PZWBPC2	Wall bracket with 2 hooks, black powder coated steel Barcode: 9325086013197
PZWBSS2	Wall bracket with 2 hooks, 304 stainless steel Barcode: 9325086013135
PZWBPC3	Wall bracket with 3 hooks, black powder coated steel Barcode: 9325086013111
PZWBSS3	Wall bracket with 3 hooks, 304 stainless steel Barcode: 9325086013128
PZWBPC4	Wall bracket with 4 hooks, black powder coated steel Barcode: 9325086013203
PZWBSS4	Wall bracket with 4 hooks, 304 stainless steel Barcode: 9325086013210



Part No **Description**
 PZER140SS Embers Rake/scraper 1400mm long handle, timber grip , 10mm dia 304 stainless steel
 Barcode: 9325086013142



PZSH140SS Shovel 1400mm long handle,timber grip, 10mm dia 304 stainless steel
 Barcode: 9325086013159



PZBS140SS Brush, natural fibre bristles, 1400mm long handle, timber grip, 10mm di 304 stainless steel
 Barcode: 9325086013166



PZTN100SS Turner , 200mm dia round blade,1000 mm long handle, timber grip, 10mm dia 304 stainless steel
 Barcode: 9325086015030



PZTN140SS Turner , 200mm dia round blade,1400 mm long handle, timber grip, 10mm dia 304 stainless steel
 Barcode: 9325086013173



PZLR140SS Log roller, 1400mm long handle, timber grip, 10mm dia 304 stainless steel
 Barcode: 9325086013180



PZBSHSB Brush, natural fibre bristles, stainless steel scraper blade, 1400mm long 30mm dia timber handle, with loop for hanging
 Barcode: 9325086013098

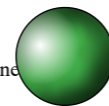



Part No. PZFSSS4

Pizza Tools Floor Stand and Tools - Stainless Steel

Includes 8mm dia x 750mm long handles on:
Embers rake/scraper, Scraper Head - 160mm wide x 70mm high
Brush with heat resistant bristles
Shovel - Head, 160mm wide
Spatula Blade - 300mm wide x 430mm long x 2mm thick



Sliding Timber Grip

Part No. PZSP100SS

Pizza Spatula - All Stainless Steel

10mm dia x 1000mm long handle with sliding support grip
Spatula - 300mm wide x 430mm long x 2mm thick
Sliding Timber grip for stability and heat protection



Part No. PZSP140SS

Pizza Spatula - All Stainless Steel - XL

10mm dia x 1400mm long handle with sliding support grip
Spatula - 300mm wide x 430mm long x 2mm thick
Sliding Timber grip for stability and heat protection



Part No. PZSPSS

Pizza Spatula - All Stainless Steel

10mm dia x 750mm long handle
Spatula Blade - 300mm wide x 430mm long x 2mm thick

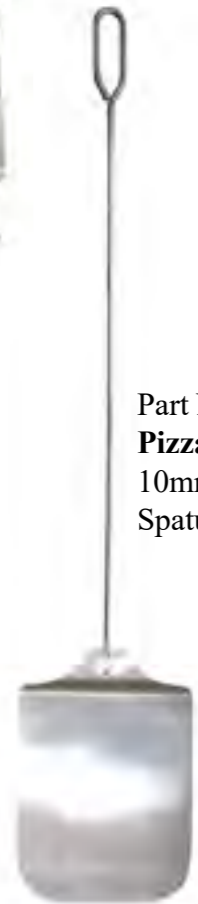

ALUMINIUM WOOD FIRED PIZZA TOOLS

Long Handle Light Weight

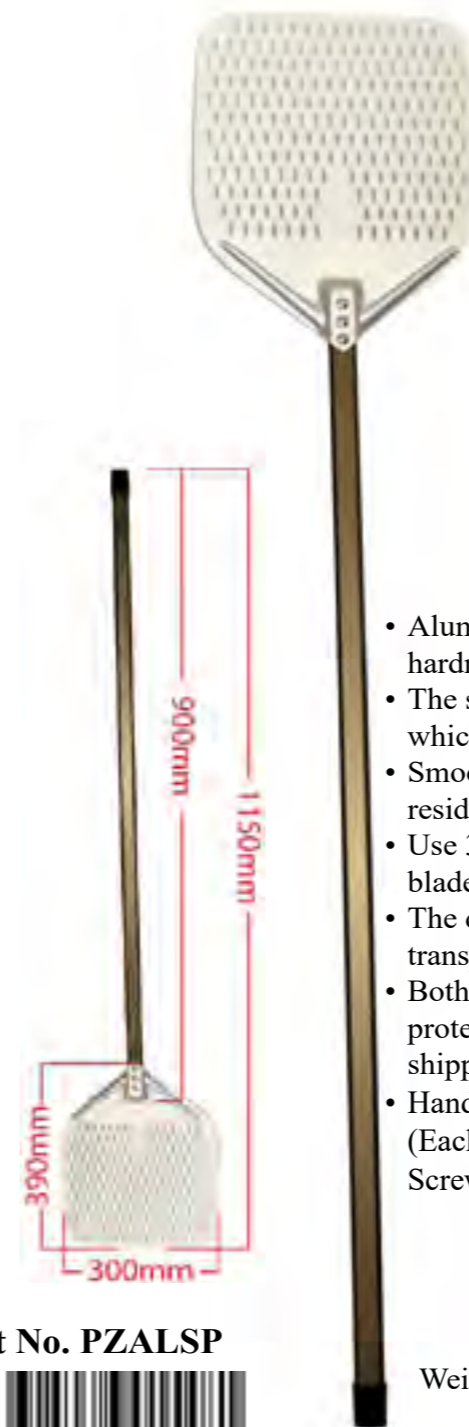

Part No. PZALSP



Weight 687g

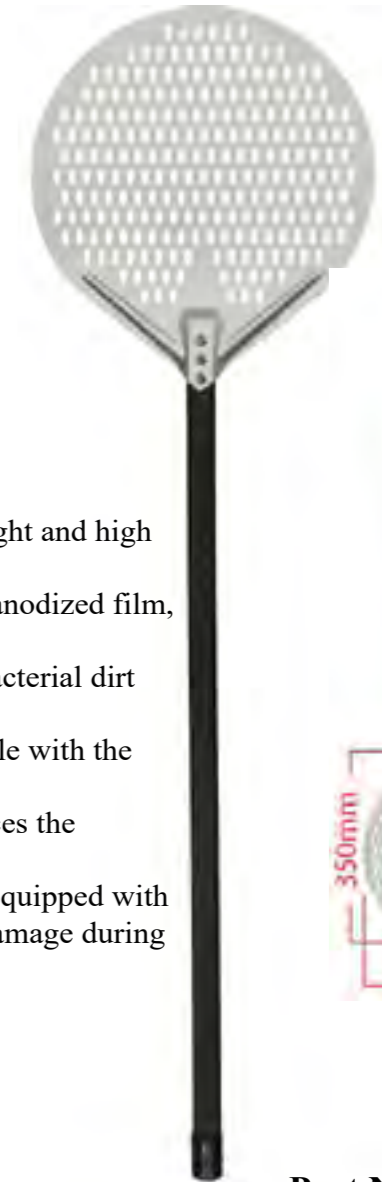

Weight 598g

- Aluminum alloy material, light and high hardness
- The surface is protected by anodized film, which is healthier and safer.
- Smooth handle to prevent bacterial dirt residue.
- Use 3 screws to fix the handle with the blade, more firmly.
- The detachable handle reduces the transportation volume.
- Both side of the handle are equipped with protective covers, prevent damage during shipping.
- Handles are 2 piece (Each 450mm L) Screw together = 900mm L

Part No. PZALTN



9 325086 015474



Pizza Oven Brush Scraper

118cm Copper bristles head with anodized aluminium alloy extend handle with ash rake function scraper

The long handle is to ensure you can reach the very back and corners of the oven, helping you to clean quickly and efficiently

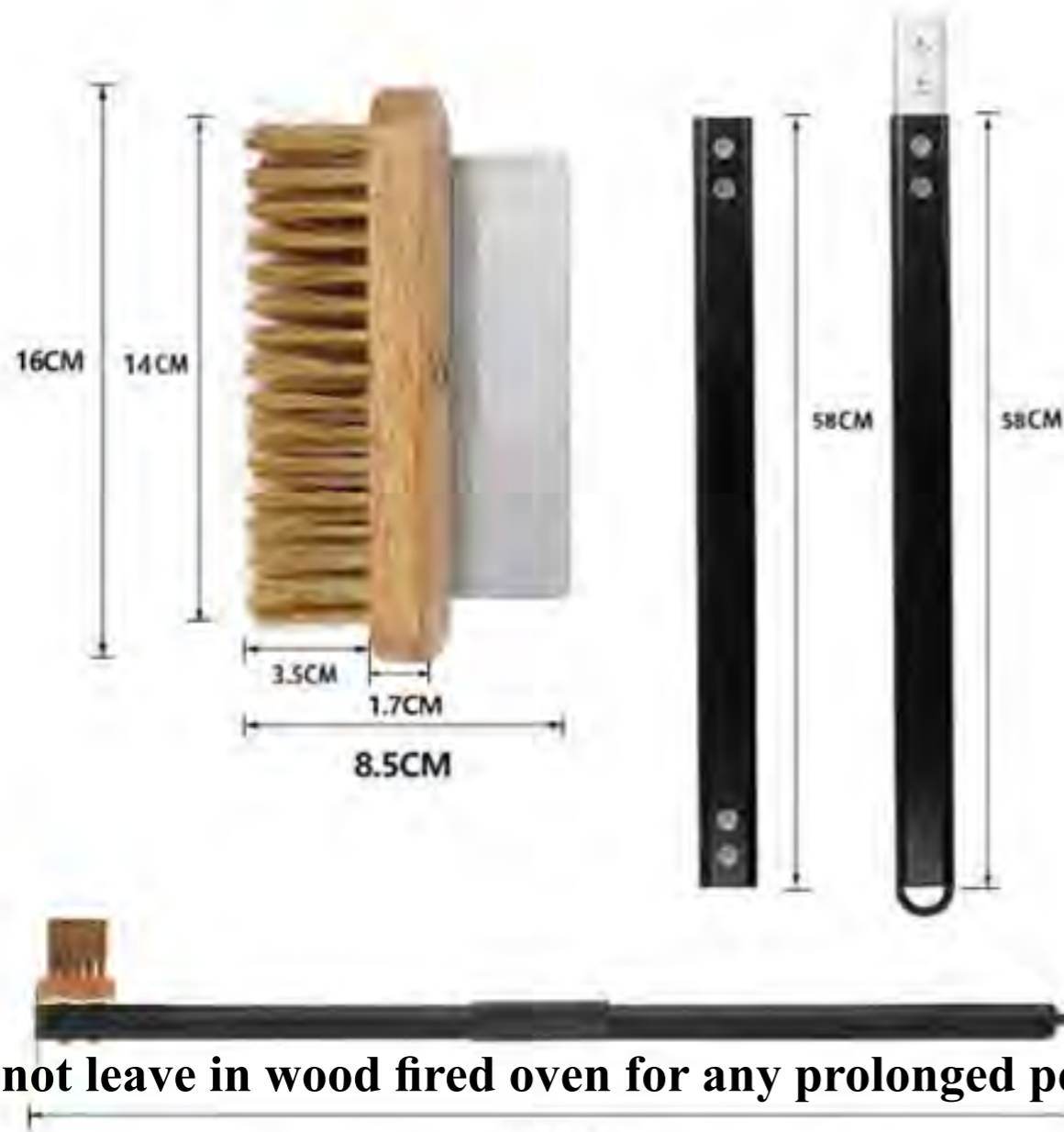

Do not leave in wood fired oven for any prolonged period

118 CM

THE ABOVE DIMENSIONS ARE MEASURED MANUALLY

Part No. PZALBR



9 325086 016327

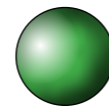

Long Handle Pizza Spatula

Part No. OM2259LH

355mm long x 305mm wide XL aluminium blade

750mm long Wooden Handle



9 325086 010011

XL Large Pizza Spatula

Part No. OM2259A

355mm long x 305mm wide aluminium blade

250mm long Moulded Folding Handle



9 325086 009961



9 325086 008353



Pizza Spatula - Stainless Steel

Part No.: OM2225SP

300mm long x 200mm wide blade

175mm long handle



Spatula with handle collapsed

Collapsed Handle

Premium Stainless Steel Pizza Cutter

with Rolled Handle

Part No.: OM2237ST

350mm L x 50-60mm D

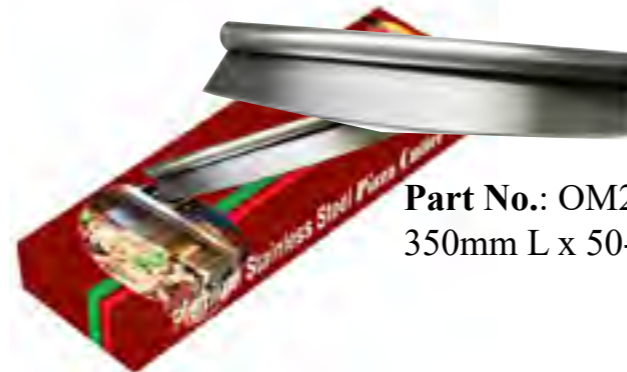

9 325086 009367

PIZZA ACCESSORIES



3 TIER PIZZA RACK

Part No. OM2268

Takes up to 3 - up to 340mm dia pizza stones

ie. Cooks small, medium or large pizzas

Cook 3 Pizzas at once in your Hooded or Kettle BBQ or in Pizza or Domestic Ovens.

Comprises - 2 wings ea 290mm L x 120mm high
- Spreader clip

When Assembled - 380mm across x 120mm high



9 325086 009978

WOODEN PIZZA PADDLE



Part No. OM2294-1



9 325086 015436

- Chisel Edge
- Easily slide pizza on and off pizza stone or tray
- Use as Server
- Can be used to serve directly to table
- 300mm wide x 380mm long overall
- 10mm thick 145mm long handle

CORDIERITE PIZZA STONE



Part No. OM2225CS-1



9 325086 015405



Cordierite Pizza Stone - 330mm dia x 11mm thick
Cordierite is a mineral known for its ability to handle extreme temperatures well.
Weight 1.6kg

PIZZA TRAYS



Aluminium Pizza Tray

250mm Round

Part No: OMPIZZA10



9 324846 064103



Aluminium Pizza Tray

280mm Round

Part No: OMPIZZA11



9 324846 064110



Aluminium Pizza Tray

300mm Round

Part No: OMPIZZA12



9 325086 015719



Aluminium Pizza Tray

330mm Round

Part No: OMPIZZA13



9 324846 064134

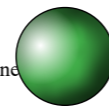



INFRARED THERMOMETER

Digital LCD Infrared Temperature Temp Gun
Thermometer Non-Contact IR Laser 550° C

Features:

- Simply point to the object or position you want to monitor and read its temperature - rated 550° C
- Ideal cooking temperature:
 - Pizzas 350° C
 - Roasting 400° C
- Laser sight allows accurate targeting
- Consist of optics, temperature sensor, signal amplifier, processing circuit and LCD display
- Celsius and Fahrenheit Indicates
- One-Handed operation
- Lightweight
- Laser on/off switch, Auto power off & temperature data hold
- Precise non-contact IR thermometer
- Suitable for: Pizza ovens, hot water pipes, hot engine parts, cooking surfaces, hot tubes insulation, electrical connection, ballasts in electric lights, electric motors, bearings, wine coolers hot asphalt, swimming pools, fish tanks, hot & cold food products, heating air conditioning, etc.
- High quality with one year warranty.



In Hang Sell Blister Pack

Part No. OMPZLGUN



9 325086 015757

Distance (D) to Spot Size (S)
D:S=12:1

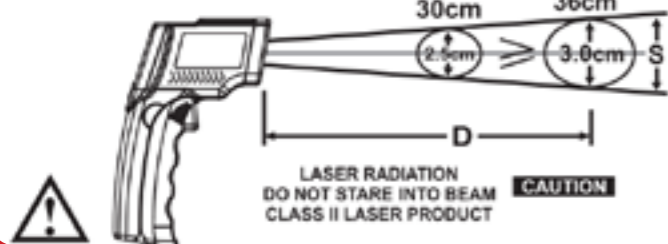

Product category	Infrared Thermometer
Accuracy	≥100°C, ±2% / ≤100°C, ±2°C
Response time	0.5S
Emissivity	Adjustable, 0.1 to 1.0
Distance to spot ratio	12:1
Storage temperature	-20 to 50°C(-4~122°F)
Operating temperature	0 to 50°C(32~122°F)
Power/Power life	2-AAA batteries/about 9 hours <i>Not Included</i>

Flaming Magic™

Available in
30g and 50g
Packs



Display Box of 50

Throw 1,2 or 3 sachets of Flaming Magic sachets into any wood burning fire. Enjoy the colours that Flaming Magic will produce. 3 sachets will give the best results. Add more sachets as colourful flames disappear. 3 x 30g sachets should last approx 30 minutes plus, subject to the conditions of the fire. For bonfires use the 50g sachets.



9 325086 015443
Part No. FLAM30
30g sachet



9 325086 015450
Part No. FLAM50
50g sachet

*Ideal for Campfires,
Firepits and Bonfires.*

Distributed by: S & D Berg Trading Pty Ltd. Melbourne, Australia





DELUXE FIREPIT & CHIMINEA COVERS

Black PVC with Flannel Backing

- Tie cords to secure
- UV Stabilized



Square Firepit Cover

Part No. OMF011J

• 660mm sq x 400mm H (Approx)

Square Firepit Cover

Part No. OMF11013B

680 x 680 x 660mm H(Approx)



Chiminea Cover - Large

Part No. OMLF129

Size- 1250mm H x ??mm W

Chiminea Cover - Medium

Part No. OM2199-4M

Size- 880mm H x 450mm W

Chiminea Cover - Small

Part No. OM2199-3M

Size- 765mm H x 400mm W



OUTDOOR HEATER COVERS



Patio Heater Cover

Part No.: PATHEA

Protects patio heater from the weather and keeps it clean

Heavy duty black vinyl, flannel backed.

Zipper & velcro tabs to secure.

Size- top dia 95cm - bottom dia 25cm - height 66cm



Patio Heater Cover

Part No.: PATHEA-M

Protects patio heater from the weather and keeps it clean

Heavy duty black vinyl, flannel backed.

Zipper & velcro tabs to secure.

Size- top dia 80cm - bottom dia 26cm - height 65cm



Area Heater Cover

Part No.: PATAH

Size- top dia 45cm

- bottom dia 45cm

- height 50cm

Velcro tab to secure

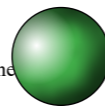



**SPANCO MANUFACTURING
HEAVY DUTY STEEL BASKET FIRE GRATES**



Part No.	Size		
SP12E	12"-290mm		
SP14E	14"-350mm		
SP48E	19"-485mm		
SP61E	24"-615mm		
SP68E	27"-680mm		
SP74E	29"-745mm		
SP87E	34"-875mm		

Specifications:

- Bearers and legs - 16mm square steel
- Plates - 8mm thick x 40mm wide flat steel
- Overall height - 160mm
- Depth - 90mm
- Front to back - 350mm
- Ash tray clearance - 50mm
- Steel grade - AS 3679-250



**SPANCO MANUFACTURING
HEAVY DUTY STEEL BASKET FIRE GRATES**

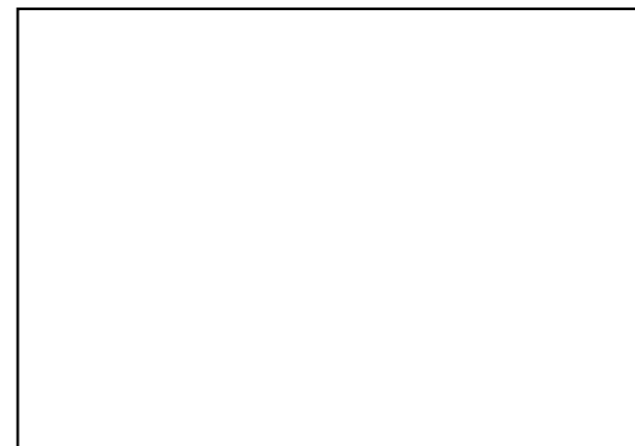

Part No.	Size		
SP18	18"-457mm		
SP24	24"-610mm		
SP28	28"-711mm		
SP30	30"-762mm		
SP36	36"-915mm		

Specifications:

- Bolt-on legs
- Steel size - 16mm solid square
- Height - 230mm
- Depth - 100mm
- Front to back - 400mm
- Colour - Black

